

APPENDIX A Operating Instructions

CS-MKS7NKU
CS-MKS9NKU
CS-MKS12NKU

(852-6-4181-214-00-2)

Operating Instructions Split System Air Conditioner

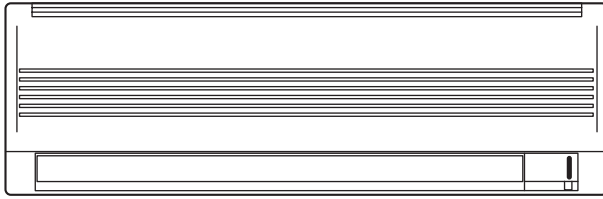

Model No.

Indoor Units

CS-MKS7NKU

CS-MKS9NKU

CS-MKS12NKU

Outdoor Units

CU-3KS19NBU

CU-4KS24NBU

CU-4KS31NBU

This air conditioner uses the refrigerant R410A.



Before operating the unit, read these operating instructions thoroughly and keep them for future reference.

FEATURES

This air conditioner is an inverter type unit that automatically adjusts capability as appropriate. Details on these functions are provided below; refer to these descriptions when using the air conditioner.

- **Microprocessor Controlled Operation**
The interior compartment of the remote controller contains several features to facilitate automatic operation, easy logically displayed for easy use.
- **Simple One-touch Remote Controller**
The remote controller has several features to facilitate automatic operation.
- **24-Hour ON or OFF Timer**
This timer can be set to automatically turn the unit on or off at any time within a 24 hour period.
- **1-Hour OFF Timer**
This timer can be set to automatically turn off the unit at any time after one hour.
- **Night Setback**
This function saves energy by controlling operation to provide a quieter operating sound than normal.
- **Automatic and 3-step Fan Speed**
Auto/High/Medium/Low
- **Air Sweep Control**
This function moves a flap up and down in the air outlet, directing air in a sweeping motion around the room and providing comfort in every corner.
- **Auto. Flap Control**
This automatically sets the flap to the optimum position during heating, cooling, and drying operation.
- **Automatic Restart Function for Power Failure**
Even when power failure occurs, preset programmed operation can be reactivated once power resumes.
- **High Power Operation**
The unit operates at maximum output for 30 minutes, regardless of the desired temperature.
The fan speed is 1 step above "High".
- **Quiet Operation**
The fan rotates slower than the fan speed setting to provide a quieter operating sound.

CONTENTS

	Page		Page
FEATURES	2	SPECIAL REMARKS	16
PRODUCT INFORMATION	2	SETTING THE TIMER	17
SAFETY PRECAUTIONS	2	USING THE 1-HOUR OFF TIMER.....	19
INSTALLATION LOCATION	3	TIPS FOR ENERGY SAVING	19
ELECTRICAL REQUIREMENTS	3	ADJUSTING THE AIRFLOW DIRECTION.....	20
SAFETY INSTRUCTIONS.....	3	OPERATION WITHOUT THE REMOTE CONTROLLER.....	21
NAMES OF PARTS	5	CARE AND CLEANING	21
USING THE REMOTE CONTROLLER	10	WIRED REMOTE CONTROLLER.....	23
OPERATION WITH THE REMOTE CONTROLLER	12	TROUBLESHOOTING (BEFORE CALLING FOR SERVICE)	24
1. Operation	12	OPERATING RANGE.....	24
2. Adjusting the Fan Speed	13	SPECIFICATIONS.....	25
3. Fan Only.....	13		
4. Night Setback Mode.....	14		
5. QUIET Mode	15		
6. HIGH POWER Mode.....	15		

PRODUCT INFORMATION

If you have problems or questions concerning your Air Conditioner, you will need the following information. Model and serial numbers are on the nameplate on the bottom of the cabinet.

Model No. _____

Serial No. _____

Date of purchase _____

Dealer's address _____

Phone number _____

SAFETY PRECAUTIONS

The following symbols used in this manual, alert you to potentially dangerous conditions to users, service personnel or the appliance:



WARNING

This symbol refers to a hazard or unsafe practice which can result in severe personal injury or death.



CAUTION

This symbol refers to a hazard or unsafe practice which can result in personal injury or product or property damage.

INSTALLATION LOCATION

- We recommend that this air conditioner be installed properly by qualified installation technicians in accordance with the Installation Instructions provided with the unit.
- Before installation, check that the voltage of the electric supply in your home or office is the same as the voltage shown on the nameplate.



WARNING

- Do not install this air conditioner where there are fumes or flammable gases, or in an extremely humid space such as a greenhouse.
- Do not install the air conditioner where excessively high heat-generating objects are placed.

EG

Avoid: To protect the air conditioner from heavy corrosion, avoid installing the outdoor unit where salty sea water can splash directly onto it or in sulphurous air near a spa.

ELECTRICAL REQUIREMENTS

1. All wiring must conform to the local electrical codes. Consult your dealer or a qualified electrician for details.
2. Each unit must be properly grounded with a ground (or earth) wire or through the supply wiring.
3. Wiring must be done by a qualified electrician.

NOTE

Pull off the power plug from a receptacle, or switch off the breaker, or switch off the power disconnecting mean to isolate the air conditioner from the main power supply when not in use for a long time.

SAFETY INSTRUCTIONS

- Read this Instruction Manual carefully before using this air conditioner. If you still have any difficulties or problems, consult your dealer for help.
- This air conditioner is designed to give you comfortable room conditions. Use this only for its intended purpose as described in this Instruction Manual.





WARNING

- Confirm to authorized dealer or specialist on usage of specified refrigerant type. Using of refrigerant other than the specified type may cause product damage, burst and injury etc.
- Never touch the unit with wet hands.
- Never use or store gasoline or other flammable vapor or liquid near the air conditioner — it is very dangerous.
- Do not use this appliance in a potentially explosive atmosphere.
- This air conditioner has no ventilator for intaking fresh air from outdoors. You must open doors or windows frequently when you use gas or oil heating appliances in the same room, which consume a lot of oxygen from the air. Otherwise there is a risk of suffocation in an extreme case.
- Do not swallow the battery.
- After removing the battery from remote controller, keep it away from the reach of children. The battery can cause death by suffocation if swallowed.
- When inserting the battery, make sure the polarities (+ and -) are correct.







WARNING

- To prevent possible hazards from insulation failure, the unit must be grounded. 
- Do not clean inside the indoor and outdoor units by users. Engage authorized dealer or specialist for cleaning.
- In case of malfunction of this appliance, do not repair by yourself. Contact to the sales dealer or service dealer for a repair.
- Refrigerant gas leakage may cause fire.
- For safety, be sure to turn the air conditioner off and also to disconnect the power before cleaning. 
- Pull off the power plug from a receptacle, or switch off the breaker, or switch off the power disconnecting mean to isolate the air conditioner from the main power supply in case of emergency.



CAUTION

- Do not turn the air conditioner on and off from the power mains switch. Use the ON/OFF operation button.
- Do not stick anything into the air outlet of the outdoor unit. This is dangerous because the fan is rotating at high speed. 
- Do not touch the air inlet or the sharp aluminum fins of the outdoor unit. You may get injured. 
- Keep the fire alarm and the air outlet at least 1.5m away from the unit.
- Do not let children play with the air conditioner.
- Do not cool or heat the room too much if babies or invalids are present.
- Do not sit or step on the unit. You may fall down accidentally. 
- Do not stick any object into the FAN CASE. You may be injured and the unit may be damaged. 

NOTICE

- **This device complies with part 15 of the FCC Rules.** Operation is subject to the following two conditions:
(1) This device may not cause harmful interference, and (2) this device must accept any interference received, including interference that may cause undesired operation.
- **This equipment has been tested and found to comply with the limits for a Class B digital device, pursuant to part 15 of the FCC Rules.** These limits are designed to provide reasonable protection against harmful interference in a residential installation. This equipment generates, uses and can radiate radio frequency energy and, if not installed and used in accordance with the instructions, may cause harmful interference to radio communications. However, there is no guarantee that interference will not occur in a particular installation. If this equipment does cause harmful interference to radio or television reception, which can be determined by turning the equipment off and on, the user is encouraged to try to correct the interference by one or more of the following measures:
 - Reorient or relocate the receiving antenna.
 - Increase the separation between the equipment and receiver.
 - Connect the equipment into an outlet on a circuit different from that to which the receiver is connected.
 - Consult the dealer or an experienced radio/TV technician for help.
- FCC Caution: To assure continued compliance, follow the attached installation instructions. Any changes or modifications not expressly approved by the party responsible for compliance could void the user's authority to operate this equipment.

NAMES OF PARTS

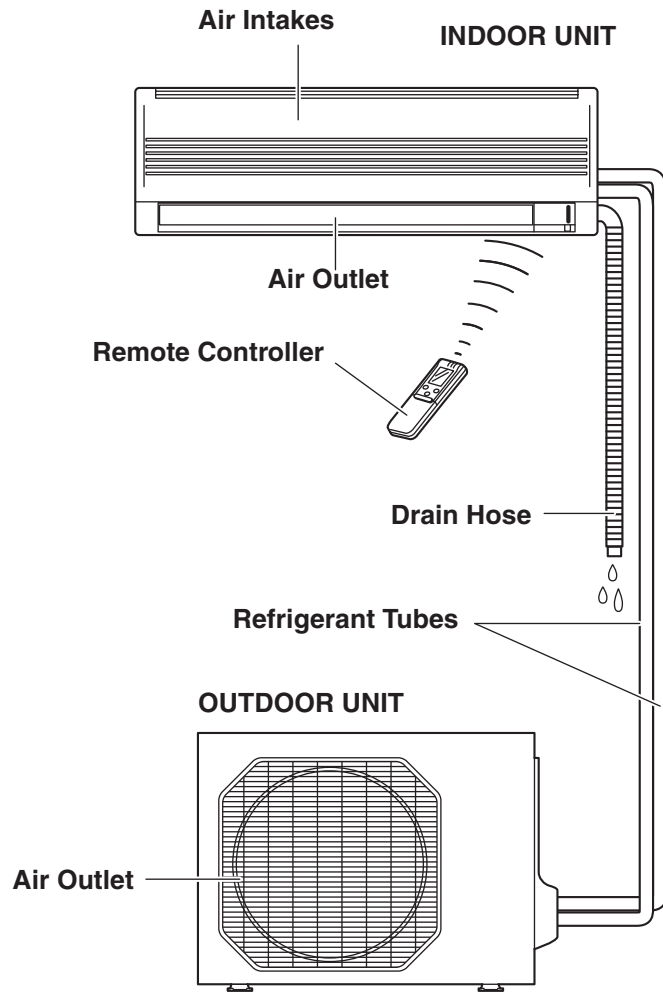

EG

NOTE

This illustration is based on the external view of a standard model. Consequently, the shape may differ from that of the air conditioner which you have selected.

This air conditioner consists of an indoor unit and an outdoor unit. You can control the air conditioner with the remote controller.

Air Intake	Air from the room is drawn into this section and passes through air filters which remove dust.
Air Outlet	Conditioned air is blown out of the air conditioner through the air outlet.
Remote Controller	The remote controller controls power ON/OFF, operation mode selection, temperature, fan speed, timer setting, and air sweeping.
Refrigerant Tubes	The indoor and outdoor units are connected by copper tubes through which refrigerant gas flows.
Drain Hose	Moisture in the room condenses and drains off through this hose.
Outdoor (Condensing) Unit	The outdoor unit contains the compressor, fan motor, heat exchanger coil, and other electrical components.

UNIT DISPLAY AND OPERATION BUTTON



IMPORTANT

Avoid using radio equipment such as mobile phone near (within 4 ft. (1.2m)) the remote control receiver. Some radio equipment may cause malfunction of the unit.

If the trouble happens, disconnect power and restart the air conditioner after a few minutes.

INDOOR UNIT

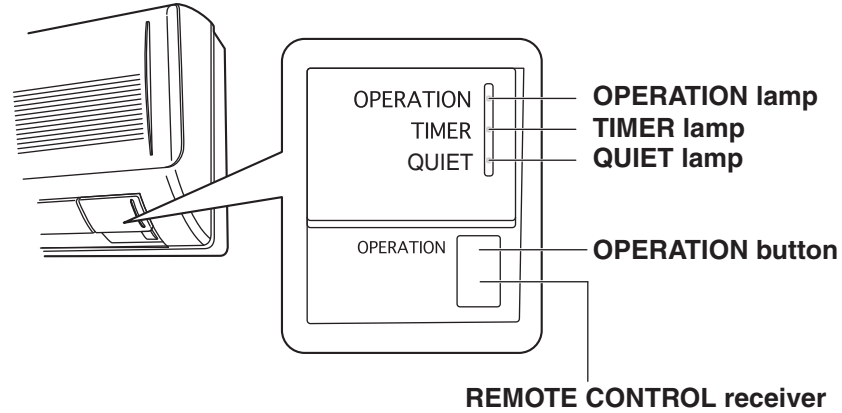

REMOTE CONTROL receiver	This section picks up infrared signals from the remote controller (transmitter).
OPERATION button	<p>When the remote controller cannot be used, pressing this button enables cooling operation.</p> <p>Each time this button is pressed, the operation mode changes cyclically.</p> <div style="text-align: center;"> <p>Cooling operation \longrightarrow Stop</p> </div>
OPERATION lamp	This lamp lights when the system is in the continuous DRY (orange), COOL (green) and FAN (green) mode.
TIMER lamp	This lamp lights when the system is being controlled by the timer.
QUIET lamp	This lamp lights during operation in the QUIET mode.

NOTE

The unit's display lamps are dimmed during operation in the NIGHT SETBACK mode.

REMOTE CONTROLLER (DISPLAY)

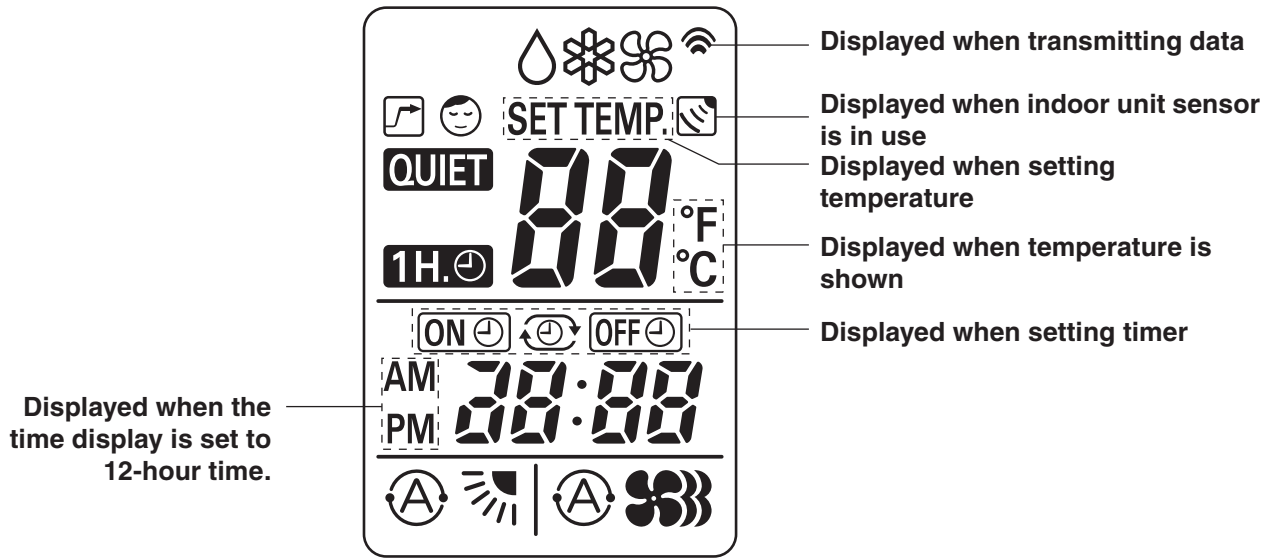

EG

Symbols

(1) Operation mode

MILD DRY



COOL



FAN



(2) Fan speed

Automatic operation



HIGH



MEDIUM



LOW



(3) Temperature setting

60 – 86 °F
When set to 80 °F
temperature indication

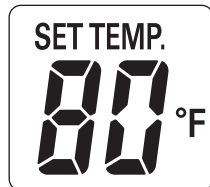

(4) Timer

24-hour clock with ON/OFF
program Timer



ON Timer



OFF Timer



1-hour OFF Timer



(5) NIGHT SETBACK



(6) Confirmation of transmission



(7) Auto. flap indication



Flap angle indication



Sweep indication



(8) High power operation



(9) Quiet operation



REMOTE CONTROLLER

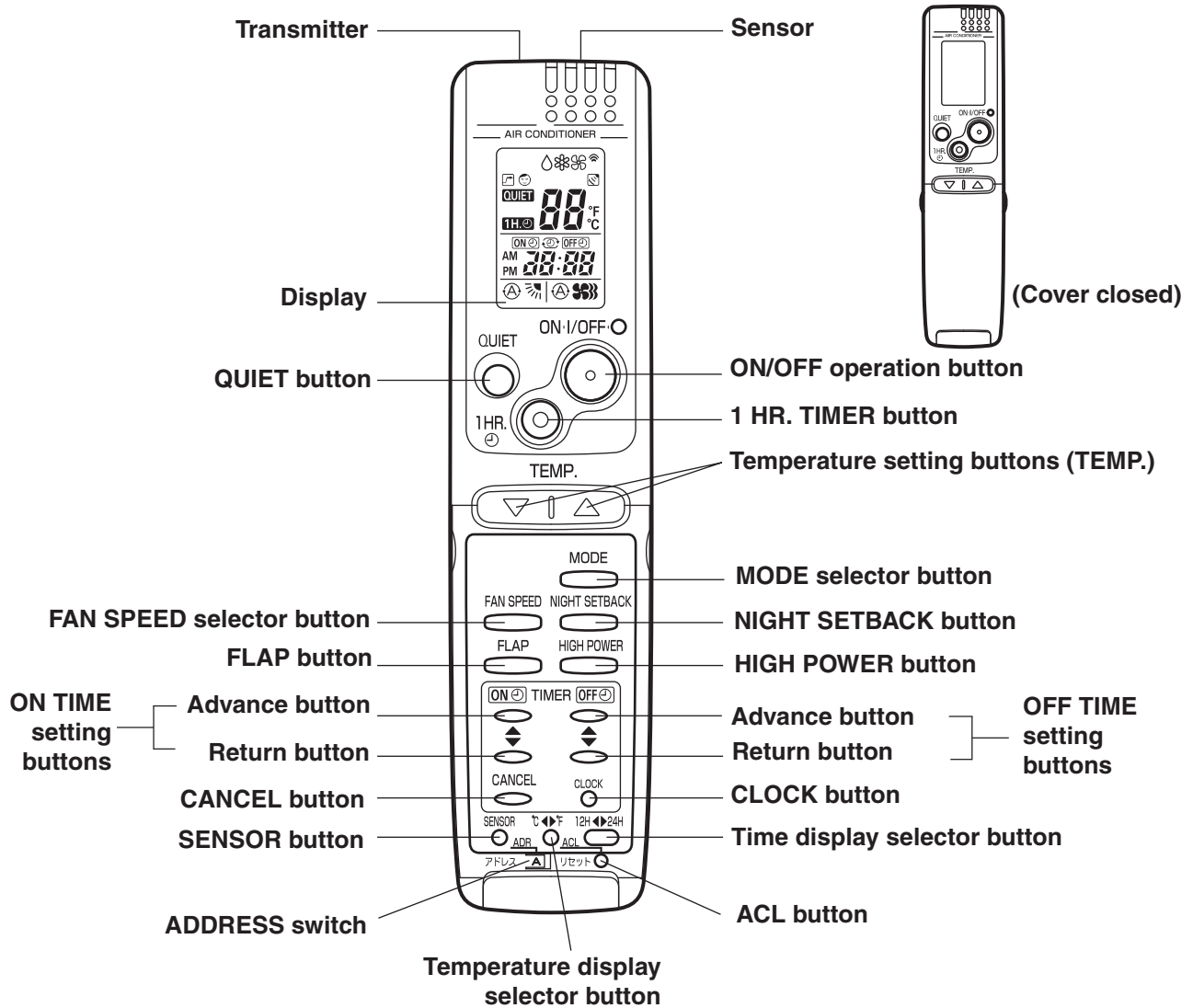

















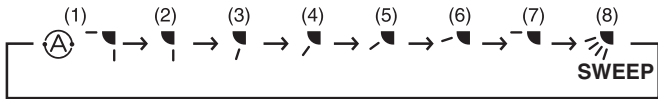

NOTE

The illustration above pictures the remote controller after the cover has been opened.

Transmitter	When you press the buttons on the remote controller, the  mark appears in the display to transmit the setting changes to the receiver in the air conditioner.
Sensor	A temperature sensor inside the remote controller senses the room temperature.
Display	Information on the operating conditions is displayed while the remote controller is switched on. If the unit is turned off, FLAP setting and FAN SPEED setting are not displayed.
QUIET button	QUIET : When you press this button, the fan rotates slower than the fan speed setting to provide a quieter operating sound.
ON/OFF operation button	This button is for turning the air conditioner on and off.
1 HR. TIMER button (1-HOUR OFF TIMER)	1H. : When you press this button, regardless of whether the unit is operating or stopping, the unit operates for one hour and then shuts down.

REMOTE CONTROLLER (CONTINUED)

<p>Temperature setting buttons (TEMP.)</p>	<p>Press the  button to increase the set temperature. Press the  button to reduce the set temperature. The temperature setting changes by 1 °C or 2 °F each time one of the TEMP. buttons is pressed.</p>
<p>MODE selector button (DRY) (COOL) (FAN)</p>	<p>Use this button to select DRY, COOL or FAN mode.</p> <ul style="list-style-type: none">  : The air conditioner reduces the humidity in the room.  : The air conditioner makes the room cooler.  : The air conditioner works only as a circulation fan.
<p>FAN SPEED selector button</p>	<ul style="list-style-type: none">  : The air conditioner automatically decides the fan speeds.  : High fan speed  : Medium fan speed  : Low fan speed
<p>NIGHT SETBACK button</p>	<p>For details, see “4. Night Setback Mode”. When you press this button in the DRY or COOL mode, the  mark appears in the display, and the remote controller will automatically adjust the set temperature to save energy.</p>
<p>FLAP button</p> <p style="text-align: right;">NOTE</p>	<p>Press this button either to select the setting of the airflow direction to the auto. flap in each mode or one of the six possible positions manually or to select the sweep function which moves the flap up and down automatically.</p> <ul style="list-style-type: none">  : Auto flap setting: If selected in a cooling or dry operation, the flap is set at position (7) in the following chart.  : The airflow direction can be set manually. (six positions)  : The flap moves up and down automatically. <p>When you press the FLAP button, the air flow direction will be changed one by one as follows.</p> <div style="text-align: center;">  </div>
<p>HIGH POWER button</p>	<ul style="list-style-type: none">  : If this button is pressed during DRY, COOL or FAN operation, the unit operates at maximum output for 30 minutes, regardless of the desired temperature. The fan speed is 1 step above “High”.
<p>ON TIME/OFF TIME setting buttons</p>	<p>No display: The timer does not operate.</p> <ul style="list-style-type: none">  : The air conditioner starts at the set time.  : The air conditioner stops at the set time.  : The air conditioner stops and starts, or starts and stops, at the set times every day. For details, see “SETTING THE TIMER”.
<p>SENSOR button</p> <p style="text-align: right;">NOTE</p>	<p>When you press this button (use a small-tipped object such as a ballpoint pen), the  mark will appear at the display. And the room temperature is detected by the sensor which is built into the indoor unit and the air conditioner is controlled accordingly.</p> <p>If the remote controller is located near a heat source, such as a space heater or in direct sunlight, press the SENSOR button to switch to the sensor on the indoor unit.</p>

EG

NOTE The indoor fan runs continuously when the system is in normal operation. It does not turn off when the desired room temperature is reached. If Night Set Back mode is selected, the fan will turn off intermittently during cooling operation in order to control air flow.

REMOTE CONTROLLER (CONTINUED)

Temperature Display Selector button	This switches the temperature display between °C and °F.
Time Display Selector button	This switches the time display between 24-hour time and 12-hour time.
ACL button (ALL CLEAR)	Puts the remote controller into pre-operation status. Always press this button after replacing the batteries.
ADDRESS switch	<ul style="list-style-type: none"> The address switch changes to prevent mixing of signals from remote controller's when two air conditioners are installed next to each other. Normally, the address switch is set to A. For more information, please contact the dealer where you made the purchase. Normally, the tabs on the remote controller should not be bent.

NOTE The remote controller sends the temperature signal to the air conditioner regularly at five minute intervals. If the signal from the remote controller stops for more than 15 minutes due to the loss of the remote controller or other trouble, the air conditioner will switch to the temperature sensor which is built into the indoor unit and control the room temperature. In these cases, the temperature around the remote controller may differ from the temperature detected at the air conditioner's position.

USING THE REMOTE CONTROLLER

How to Install Batteries

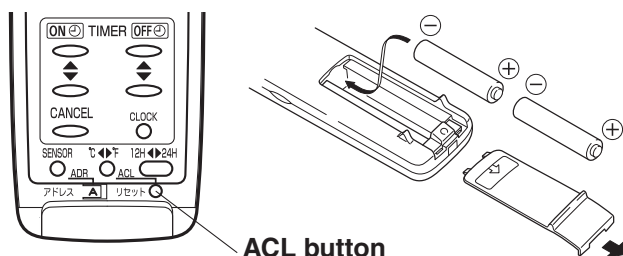

- Slide the cover in the direction indicated by the arrow and remove it.
- Install two AAA alkaline batteries. Make sure the batteries point in the direction marked in the battery compartment.
- Use a thin object such as the tip of a pen to press the ACL button.



CAUTION

- The batteries last about six months, depending on how much you use the remote controller. Replace the batteries when the remote controller's display fails to light, or when the remote controller cannot be used to change the air conditioner's settings.
- Use two fresh leak-proof type-AAA alkaline batteries.
- In replacing batteries, follow the instructions as mentioned in the subsection "How to Install Batteries".
- If you do not use the remote controller more than 1 month, take out the batteries.
- Dispose of the used batteries at the designated location in compliance with the applicable local ordinances.

Information for Users on Collection and Disposal of Old Equipment and used Batteries



[Information on Disposal in other Countries outside the European Union]
These symbols are only valid in the European Union. If you wish to discard these items, please contact your local authorities or dealer and ask for the correct method of disposal.



Pb

Note for the battery symbol (bottom two symbol examples):

This symbol might be used in combination with a chemical symbol. In this case it complies with the requirement set by the Directive for the chemical involved.

USING THE REMOTE CONTROLLER (CONTINUED)

How to Use the Remote Controller

When using the remote controller, always point the unit's transmitter head directly at the air conditioner's receiver.

**Air Conditioner
(Indoor unit)**

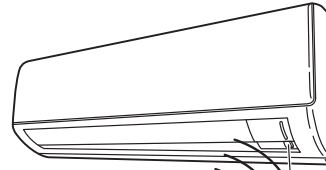

Remote Controller

**Receiver
(Transmitter head)**

EG

Remote Controller Installation Position

The remote controller may be operated either from a non-fixed position or from a wall-mounted position. To ensure that the air conditioner operates correctly, do not install the remote controller in the following places:

- In direct sunlight
- Behind a curtain or other places where it is covered
- More than 26 ft (8 m) away from the air conditioner
- In the path of the air conditioner's airstream
- Where it may become extremely hot or cold
- Where it may be subject to electrical or magnetic noise
- Where there is an obstacle between the remote controller and air conditioner (since a check signal is sent from the remote controller every 5 minutes)

Mounting the Remote Controller

Before mounting the remote controller, press the ON/OFF operation button at the mounting location to make sure that the air conditioner operates from that location. The indoor unit should make a beeping sound to indicate that it has received the signal.

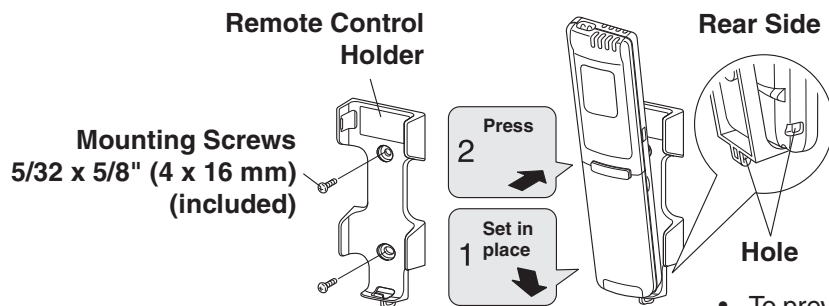

- To prevent loss of the remote controller, you can connect the remote controller to the holder by passing a string through the remote controller and attachment hole.

To take out the remote controller, pull it forward.

When Holding the Remote Controller

- When using the remote controller and during air conditioner operation, the transmitter on the remote controller should be pointed towards the receiver on the indoor unit.
- Make sure that there are no objects between the remote controller and receiver which could block the signal.

OPERATION WITH THE REMOTE CONTROLLER

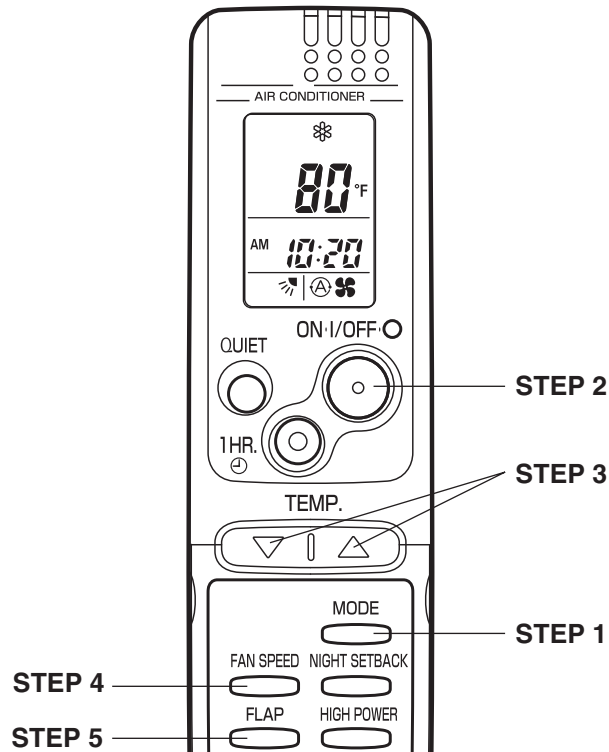

1. Operation



NOTE

Check that the circuit breaker on the power panel is turned on.

Press the setting buttons as described below and change the settings as desired.

STEP 1	Press the MODE selector button and select the desired mode. For dehumidifying operation →  For cooling operation →  For fan only operation → 
STEP 2	To start the air conditioner, press the ON/OFF operation button.
STEP 3	Press the TEMP. setting buttons to change the temperature setting to the desired temperature. Adjustable temperature range: 30 °C max. or 86 °F max. 16 °C min. 60 °F min.
STEP 4	Set the FAN SPEED selector button to the setting you want.
STEP 5	Press the FLAP button and set the airflow direction as desired. (Refer to “ADJUSTING THE AIRFLOW DIRECTION” on page 20.)

To stop the air conditioner, press the ON/OFF operation button again.

OPERATION WITH THE REMOTE CONTROLLER (CONTINUED)

NOTE

- Choose the best position in the room for the remote controller, which also acts as the sensor for room comfort and transmits the operating instructions. Once you've found this best position, always keep the remote controller there.
- This appliance has a built-in 5-minute time delay circuit to ensure reliable operation. When the operation button is pressed, the compressor will start running within three minutes. In the event of power failure, the unit will stop.



EG

2. Adjusting the Fan Speed

A. Automatic fan speed

Simply set the FAN SPEED selector button to the  position. This automatically sets the best fan speed for the room temperature.



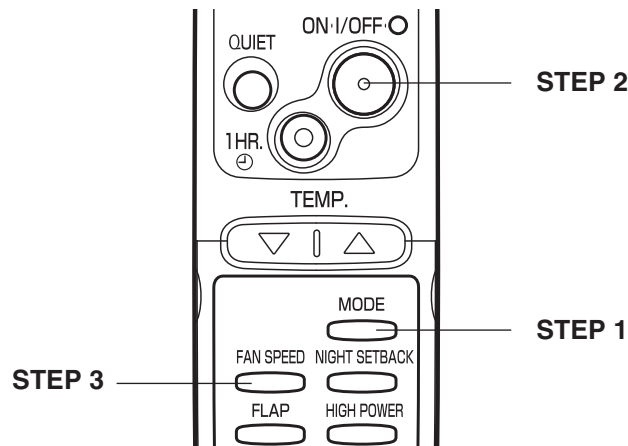

B. Manual fan speed

If you want to adjust fan speed manually during operation, just set the FAN SPEED selector button as desired. [, , or ]

3. Fan Only



If you want to circulate air without any temperature control, follow these steps:

STEP 1	Press the MODE selector button to switch to the fan mode  .
STEP 2	Press the ON/OFF operation button.
STEP 3	Press the FAN SPEED selector button to select the fan speed of your choice ( ,  , or ).

OPERATION WITH THE REMOTE CONTROLLER (CONTINUED)

4. Night Setback Mode

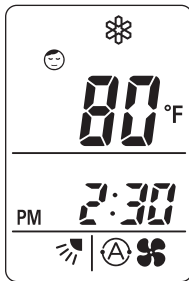

Night Setback Mode is used for saving energy.

Press the NIGHT SETBACK button while unit is operating.
The ☺ mark appears in the display.

To release the night setback function, press the NIGHT SETBACK button again.

NOTE

Pressing the MODE selector button cancels Night Setback mode.

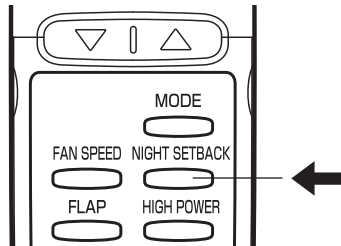

In Cooling and DRY Mode: (❄️ and 💧)

When the night setback mode is selected, the air conditioner automatically raises the temperature setting 2 °F when 30 minutes have passed after the selection was made, and then another 2 °F after another 30 minutes have passed, regardless of the indoor temperature when night setback was selected. This enables you to save energy without sacrificing comfort. This function is convenient when gentle cooling is needed.

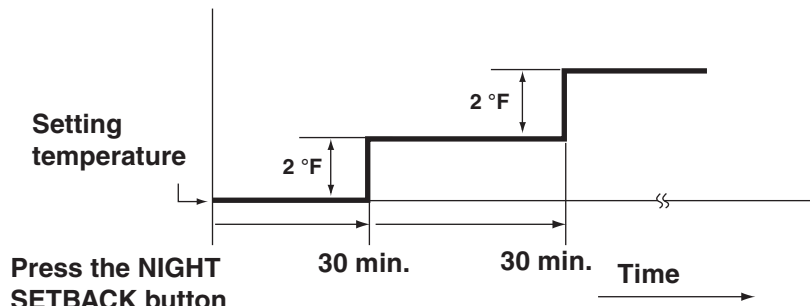

OPERATION WITH THE REMOTE CONTROLLER (CONTINUED)

5. QUIET Mode

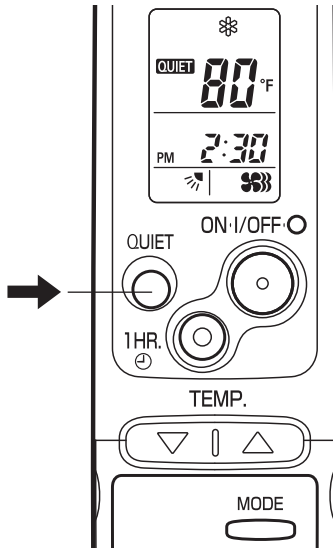

QUIET Mode is used to reduce the fan sound of the indoor unit.

Press the QUIET button.

The **QUIET** mark appears in the display.

To cancel, press QUIET button again.

- In QUIET Mode, the fan rotates at a slower speed than the fan speed setting.
- If the unit is already operating with a very low airflow, the fan sound may not change even if the QUIET button is pressed.

EG

6. HIGH POWER Mode

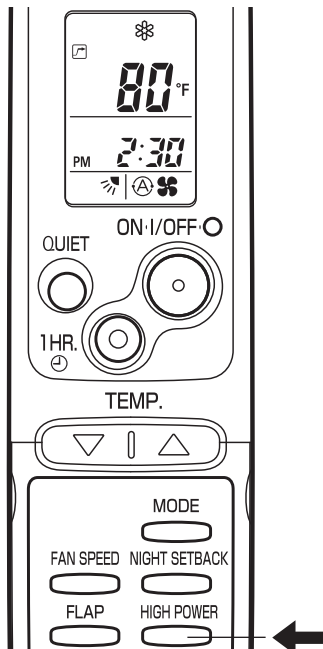

HIGH POWER mode can be used to increase the output of the indoor unit for all operation modes.

Press the HIGH POWER button while unit is operating.

The  mark appears in the display.

To cancel, press HIGH POWER button again.

- When the HIGH POWER button is pressed, the unit operates at maximum output for 30 minutes, regardless of the desired temperature. The fan speed is 1 step above "High".
- QUIET Mode and HIGH POWER Mode cannot be used at the same time.

NOTE

- Pressing the MODE selector button cancels HIGH POWER mode.
- Depending on the operating conditions, the fan speed may be increased by a small amount only.

SPECIAL REMARKS

“DRY” (☺) Operation

How it works?

- Once the room temperature reaches the level that was set, the unit’s operation frequency is changed automatically.
- During DRY operation, the fan speed automatically runs at lower speed for providing a comfortable breeze.
- “DRY” operation is not possible if the indoor temperature is 59 °F or less.

Cooling (☼) Operation

- Sometimes the indoor unit may not get to the set fan speed such as LOW and QUIET under cool operation at very low outdoor temperatures due to the indoor unit being protected from ice or frost when combined with the outdoor unit for Low Ambient Cooling models.

Power failure during operation

- In the event of power failure, the unit will stop. When the power is resumed, the unit will restart automatically within 15 minutes by the remote controller.

Clicking Sound

Clicking sound is heard from the air conditioner

- In cooling operation, any plastic parts may shrink due to a sudden temperature change. In this event, a clicking sound may occur. This is normal, and the sound will soon disappear.

Remote Controller

- The remote controller sends the setting condition to the air conditioner regularly at five minute intervals.

SETTING THE TIMER

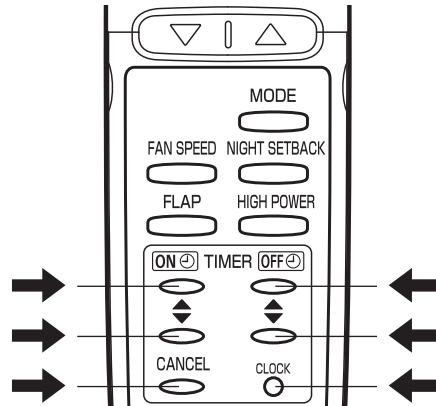

EG

NOTE

In the descriptions below, the following settings are used for the temperature and time indicator selector button on the bottom front section of the remote controller.

- Temperature: °F
- Time: AM, PM

1. How to set the present time

(Example) To set to 10:30 pm.

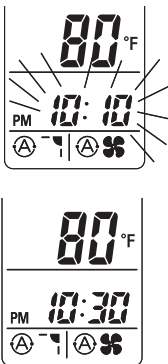

Operation	Indication
1. Press the CLOCK button once if the time indicator is not flashing.	The time indication alone flashes.
2. Press the Advance, Return (▲, ▼) button until PM 10:30 is displayed.	The time can be set in 1-minute increments. Holding down the button advances the time rapidly in 10-minute increments.
3. Press the CLOCK button again.	This completes the setting of the current time.

2. How to set the OFF time

(Example) To stop the air conditioner at 11:00 am.



Operation	Indication
1. Press the OFF TIME setting button once.	The timer OFF TIME indication is displayed, and the present OFF time is shown.
2. Press the Advance, Return (▲, ▼) button until AM 11:00 is displayed.	The timer OFF TIME indication blinks. The time can be set in 10-minute increments. Holding down the button advances the time rapidly in 10-minute increments.
3. Wait a few seconds, and then the setting is complete.	The timer OFF TIME indication stops blinking and the present time is displayed.

SETTING THE TIMER (CONTINUED)

3. How to set the ON time

(Example) To start operation at 7:10 am.

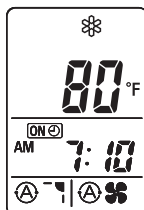

Operation	Indication
1. Press the ON TIME setting button once.	The timer ON indication is displayed, and the present ON time is shown.
2. Press the Advance, Return (▲, ▼) button until AM 7:10 is displayed.	The timer ON indication blinks. The time can be set in 10-minute increments. Holding down the button advances the time rapidly in 10-minute increments.
3. Wait a few seconds, and then the setting is complete.	The timer ON indication stops blinking and the present time is displayed.

4. How to set DAILY ON/OFF REPEAT timer

(Example) To start operation at 7:10 am. and stop the air conditioner at 11:00 am.

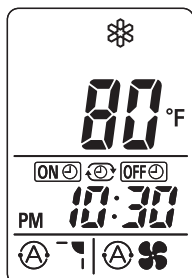
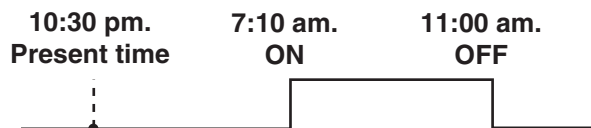

Operation	Indication
1. Set the timer ON/OFF times as shown in 2-1, 2, 3 and 3-1, 2, 3.	The present time 10:30 pm. and ON OFF are displayed.

NOTE

- The ON/OFF combination timer uses the current time as the reference, and it is activated starting from whichever set time comes first.
- With the ON/OFF combination timer, the settings are repeated every day.
- You can check the timer ON/OFF times after you have set them by pressing the ON TIME and OFF TIME setting buttons.

To cancel a timer program

- Press the CANCEL button.
- When either an ON or OFF timer is to be canceled, press the button corresponding to the timer whose program is to be canceled, and then press the CANCEL button.

NOTE

- The airflow direction, fan speed and temperature setting can be changed after a timer program has been set even when the unit is stopped. Even when operation is stopped during an ON timer program, the unit will start operating when the set time is reached provided that the program is not canceled.
- When the ON timer and OFF timer are set to the same time, the timer operates as if it is turned off.

USING THE 1-HOUR OFF TIMER

1. 1-Hour OFF Timer

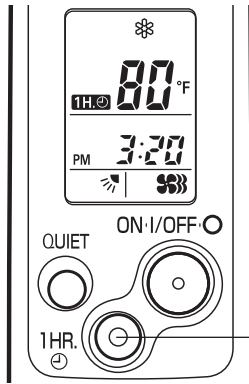

This function causes the unit to operate for one hour and then stop, regardless of whether the unit is on or off when this button is pressed. The **1H.** indicator in the display indicates that this function is operating.

Setting procedure:

Regardless of whether the unit is operating or stopped, press the 1 HR. TIMER button.

1H. appears in the display.

Cancellation procedure:

Press the ON/OFF operation button to turn the unit off, wait for the unit to stop operating, and then press the ON/OFF operation button again.

The 1-Hour Timer function is now cancelled and the unit operates normally.

NOTE

- If, while the 1-Hour Timer function is operating, the 1HR. TIMER button is pressed once to cancel the function and then again, the unit continues to operate for one hour from that point in time and then stops.
- It is not possible to use the OFF Timer and 1-Hour OFF Timer together. Whichever function is set last takes precedence. If the 1 HR. TIMER button is pressed while the TIMER OFF function operates, the OFF Timer is cancelled and the unit will stop operating one hour later.

2. Operation together with the DAILY ON/OFF REPEAT Timer

The 1-Hour OFF Timer setting is given priority over the DAILY ON/OFF REPEAT setting.

TIPS FOR ENERGY SAVING

- Avoid**
- **Do not block neither the air intake nor the air outlet. It may cause less performance, and may leads to malfunctions.**
 - Do not let direct sunlight into the room. Use sunshades, blinds or curtains. If the walls and ceiling of the room are warmed by the sun, it will take longer to cool the room.
- Do**
- Always try to keep the air filter clean. (Refer to “CARE AND CLEANING”.) A clogged filter will impair the performance of the unit.
 - To prevent conditioned air from escaping, keep windows, doors and any other openings closed.

ADJUSTING THE AIRFLOW DIRECTION

- 1. Horizontal** The horizontal airflow can be adjusted by moving the vertical vanes with your hands to the left or right.

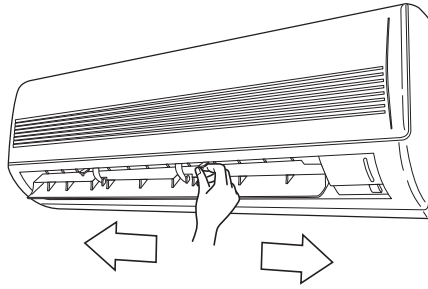

CAUTION

When the humidity is high, the vertical vanes should be in the front position during the cooling or dehumidifying operation. If the vertical vanes are positioned all of the way to the right or left, condensation may begin to form around the air vent and drip down.

- 2. Vertical** The vertical airflow can be adjusted by moving the flap with the remote controller. Do not move the flap with your hands. Confirm that the remote controller has been turned on. Use the FLAP button to set either the sweep function or one of the six airflow direction settings.

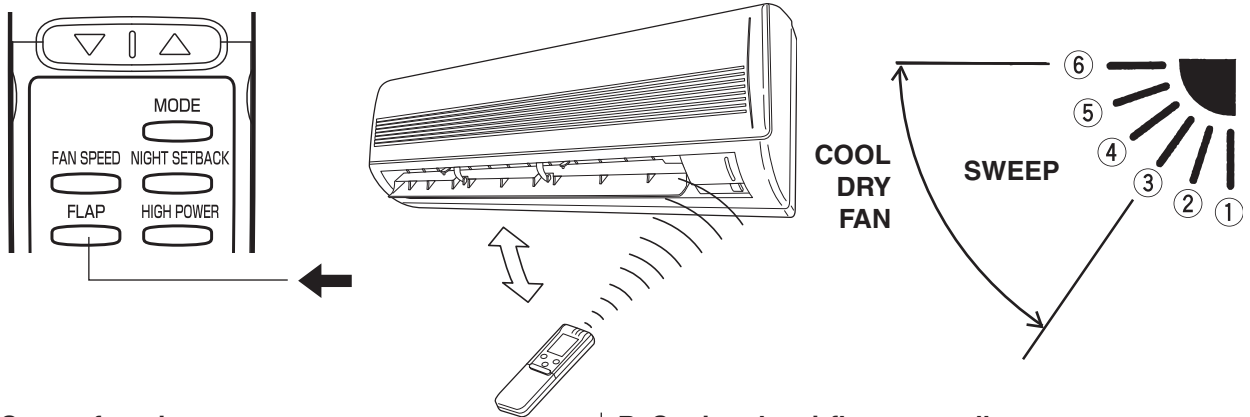

A. Sweep function



The flap starts moving up and down to deliver air over the sweep range.

C. Auto flap function



The flap is set to the recommended position.

B. Setting the airflow manually



Referring to the above illustration, use the FLAP button to set the airflow direction within the range used during the cooling or dehumidifying operation.

NOTE

- The flap automatically closes when the unit is off.



CAUTION

- Use the FLAP button on the remote controller to adjust the position of the flap. If you move the flap by hand, the flap position according to the remote controller and the actual flap position may no longer match. If this should happen, shut off the unit, wait for the flap to close, and then turn on the unit again; the flap position will now be normal again.
- Do not have the flap pointed down during cooling operation. Condensation may begin to form around the air vent and drip down.

OPERATION WITHOUT THE REMOTE CONTROLLER

INDOOR UNIT

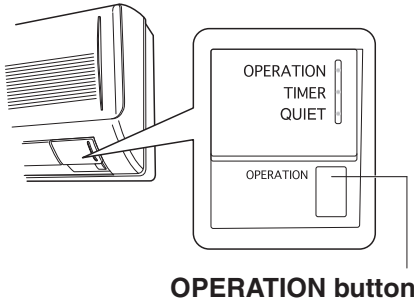

OPERATION button

If you have lost the remote controller or it has trouble, follow the steps below.

When the air conditioner is not running

Each time the OPERATION button is pressed, the operation mode changes cyclically.



NOTE

The temperature is set to the room temperature minus 4 °F during the cooling operation, and the fan speed and flap are set to Auto.

CARE AND CLEANING



WARNING

1. For safety, be sure to turn the air conditioner off and also to disconnect the power before cleaning.
2. Do not pour water on the indoor unit to clean it. This will damage the internal components and cause an electric shock hazard.

Casing and Grille (Indoor Unit)

Clean the casing and grille of the indoor unit with a vacuum cleaner brush, or wipe them with a clean, soft cloth.

If these parts are stained, use a clean cloth moistened with a mild liquid detergent. When cleaning the grille, be careful not to force the vanes out of place.



CAUTION

1. Never use solvents, or harsh chemicals when cleaning the indoor unit. Do not wipe the plastic casing using very hot water.
2. Some metal edges and the fins are sharp and may cause injury if handled improperly; be especially careful when you clean these parts.
3. The internal coil and other components of the outdoor unit must be cleaned every year. Consult your dealer or service center.

CARE AND CLEANING (CONTINUED)

Filter The filter behind the air intake grille should be checked and cleaned at least once every two weeks.

How to remove the filter

1. Grasp both ends of the air intake grille, and remove it by opening towards the front and pulling towards you.

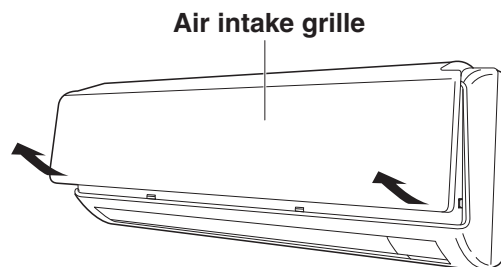

2. Remove the filter attached to the rear of the air intake grille.

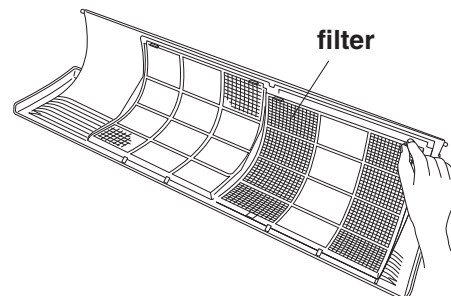

Cleaning Use a vacuum cleaner to remove light dust. If there is sticky dust on the filter, wash the filter in lukewarm, soapy water, rinse it in clean water, and dry it.

How to replace the filter

1. With the FRONT mark of the filter at the front, align the two indentions near the mark with the hooks at the rear of the air intake grille, and then mount the filter.

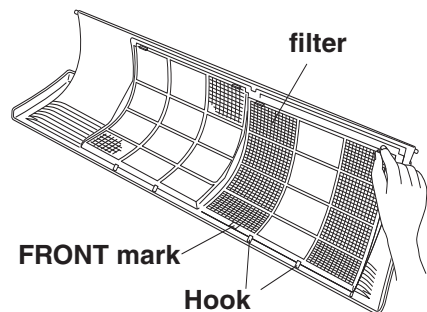

2. Allow the edge of the air intake grille to slide into the top of the indoor unit, and then insert it all the way inside.

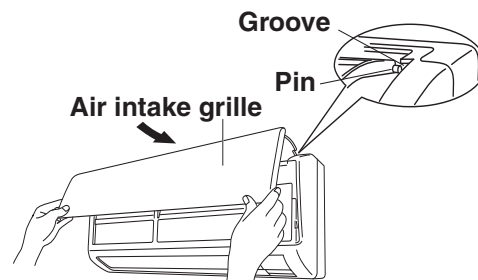

3. Press in the bottom right and left corners of the air intake grille to attach the indoor unit.

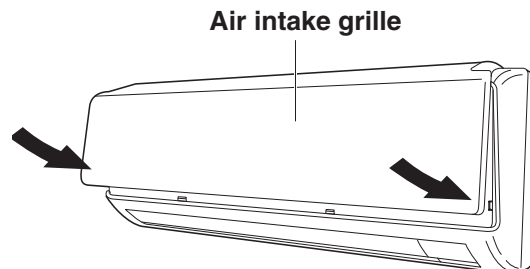

NOTE

Attach so that the round pins at the top right and left corners of the air intake grille are inserted into the grooves at the top right and left of the indoor unit.

CARE AND CLEANING (CONTINUED)

Cleaning the main unit and Remote Controller

- Wipe clean using a soft, dry cloth.
- To remove stubborn dirt, moisten a cloth in warm water no hotter than 104 °F, wring thoroughly, and then wipe.
- The air intake grille can be removed in order to wash it with water.

Removing and remounting the air intake grille

Refer to “How to remove the filter” and “How to replace the filter” on page 22.



CAUTION

When using a footstool or the like, be careful not to let it tip over.

EG

Washing the grille with water

- Clean the grille gently using a soft sponge, or the like. Then wipe away any remaining moisture.
- Neutral detergent may be used to remove stubborn dirt. Then rinse thoroughly with water and wipe away any remaining moisture.

WIRED REMOTE CONTROLLER

A separately sold wired remote controller (CZ-RD515U) used with this air conditioner is also available. If you wish to use the wired remote control function, you will need to purchase both the optional wired remote controller and its connection kit (CZ-RC515U).

TROUBLESHOOTING (BEFORE CALLING FOR SERVICE)

If your air conditioner does not work properly, first check the following points before requesting service. If it still does not work properly, contact your dealer or service center.

Trouble	Possible Cause	Remedy
Air conditioner does not run at all.	<ol style="list-style-type: none"> 1. Power failure. 2. Leakage circuit breaker tripped. 3. Line voltage is too low. 4. Batteries in remote controller have run down. 	<ol style="list-style-type: none"> 1. Restore power. 2. Contact service center. 3. Consult your electrician or dealer. 4. Replace batteries.
OPERATION lamp blinks and air conditioner does not operate.	Trouble in system.	Contact service center.
Compressor runs but soon stops.	Obstruction in front of condenser coil. (Outdoor Unit)	Remove obstruction.
Poor cooling performance.	<ol style="list-style-type: none"> 1. Dirty or clogged air filter. 2. Heat source or many people in room. 3. Doors and/or windows are open. 4. Obstacle near air intake or air discharge port. 5. Thermostat is set too high for cooling. 	<ol style="list-style-type: none"> 1. Clean air filter to improve airflow. 2. Eliminate heat source if possible. 3. Shut them to keep the heat out. 4. Remove it to ensure good airflow. 5. Set the temperature lower.
Clicking sound is heard from the air conditioner.	In cooling operation, any plastic parts may shrink due to a sudden temperature change. In this event, a clicking sound may occur.	This is normal, and the sound will soon disappear.
OPERATION lamp lights but outdoor unit will not run.	The use of cellular phones near the air conditioner may cause disturbance to its normal operation.	<ol style="list-style-type: none"> 1. Turn off the power then restart the air conditioner after a while. 2. Consult your dealer.

OPERATING RANGE

The air conditioner is operable within the temperature ranges as listed below:

	Temperature	Indoor air temperature	Outdoor air temperature
COOLING	Max.	95 °F DB / 71 °F WB	115 °F DB
	Min.	67 °F DB / 57 °F WB	14 °F DB

SPECIFICATIONS

Model No.		Indoor Unit			
		CS-MKS7NKU	CS-MKS9NKU	CS-MKS12NKU	
Power Source		Single-phase, 208-230 V, 60 Hz			
Cooling Capacity	kW	2.20	2.65	3.50	
	BTU/h	7,500	9,000	11,900	
Heating Capacity	kW	–	–	–	
	BTU/h	–	–	–	
Operation Sound	Cooling Operation (H/M/L)	dB(A)	33/30/27	34/31/28	
	Heating Operation (H/M/L)	dB(A)	–	–	
Unit Dimensions (H×W×D) (Indoor unit : Include panel)		inch(mm)	11-7/32×32-15/32×7-7/16 (285×825×189)	11-7/32×32-15/32×7-7/16 (285×825×189)	11-7/32×32-15/32×7-7/16 (285×825×189)
Net Weight		lbs.(kg)	19.8(9.0)	19.8(9.0)	19.8(9.0)

EG

Model No.		Outdoor Unit			
		CU-3KS19NBU	CU-4KS24NBU	CU-4KS31NBU	
Power Source		Single-phase, 208-230 V, 60 Hz			
Cooling Capacity	kW	5.50 [2.90 ~ 5.50]	7.50 [2.90 ~ 7.50]	9.00 [2.90 ~ 9.00]	
	BTU/h	18,800 [9,800 ~ 18,800]	25,400 [9,800 ~ 25,400]	30,600 [9,800 ~ 30,600]	
Heating Capacity	kW	–	–	–	
	BTU/h	–	–	–	
Operation Sound	Cooling Operation (Hi)	dB(A)	50	50	
	Heating Operation (Hi)	dB(A)	–	–	
Unit Dimensions (H×W×D)		inch(mm)	29-1/8×35-7/16×12-19/32 (740×900×320)	29-1/8×35-7/16×12-19/32 (740×900×320)	35-1/32×35-7/16×12-19/32 (890×900×320)
Net Weight		lbs.(kg)	138.9(63.0)	138.9(63.0)	174.2(79.0)

APPENDIX B Operating Instructions

CS-MKS18NKU
CS-MKS24NKU

(852-6-4181-215-00-1)

Operating Instructions Split System Air Conditioner

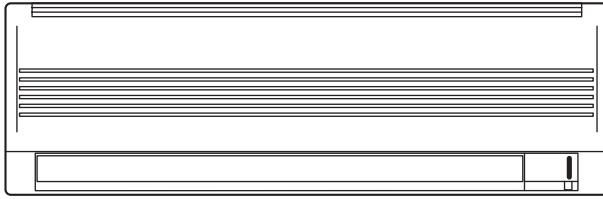

Model No.

Indoor Units

CS-MKS18NKU

CS-MKS24NKU

Outdoor Units

CU-3KS19NBU

CU-4KS24NBU

CU-4KS31NBU

This air conditioner uses the refrigerant R410A.



Before operating the unit, read these operating instructions thoroughly and keep them for future reference.

FEATURES

This air conditioner is an inverter type unit that automatically adjusts capability as appropriate. Details on these functions are provided below; refer to these descriptions when using the air conditioner.

- **Microprocessor Controlled Operation**
The interior compartment of the remote controller contains several features to facilitate automatic operation, easy logically displayed for easy use.
- **Simple One-touch Remote Controller**
The remote controller has several features to facilitate automatic operation.
- **24-Hour ON or OFF Timer**
This timer can be set to automatically turn the unit on or off at any time within a 24 hour period.
- **1-Hour OFF Timer**
This timer can be set to automatically turn off the unit at any time after one hour.
- **Night Setback**
This function saves energy by controlling operation to provide a quieter operating sound than normal.
- **Automatic and 3-step Fan Speed**
Auto/High/Medium/Low
- **Air Sweep Control**
This function moves a flap up and down in the air outlet, directing air in a sweeping motion around the room and providing comfort in every corner.
- **Auto. Flap Control**
This automatically sets the flap to the optimum position during heating, cooling, and drying operation.
- **Automatic Restart Function for Power Failure**
Even when power failure occurs, preset programmed operation can be reactivated once power resumes.
- **High Power Operation**
The unit operates at maximum output for 30 minutes, regardless of the desired temperature.
The fan speed is 1 step above "High".
- **Quiet Operation**
The fan rotates slower than the fan speed setting to provide a quieter operating sound.

CONTENTS

	Page		Page
FEATURES.....	2	SPECIAL REMARKS	16
PRODUCT INFORMATION	2	SETTING THE TIMER	17
SAFETY PRECAUTIONS.....	2	USING THE 1-HOUR OFF TIMER.....	19
INSTALLATION LOCATION.....	3	TIPS FOR ENERGY SAVING	19
ELECTRICAL REQUIREMENTS	3	ADJUSTING THE AIRFLOW DIRECTION.....	20
SAFETY INSTRUCTIONS.....	3	OPERATION WITHOUT THE REMOTE CONTROLLER.....	21
NAMES OF PARTS	5	CARE AND CLEANING	21
USING THE REMOTE CONTROLLER	10	WIRED REMOTE CONTROLLER.....	23
OPERATION WITH THE REMOTE CONTROLLER	12	TROUBLESHOOTING (BEFORE CALLING FOR SERVICE)	24
1. Operation	12	OPERATING RANGE.....	24
2. Adjusting the Fan Speed.....	13	SPECIFICATIONS.....	25
3. Fan Only.....	13		
4. Night Setback Mode.....	14		
5. QUIET Mode	15		
6. HIGH POWER Mode.....	15		

PRODUCT INFORMATION

If you have problems or questions concerning your Air Conditioner, you will need the following information. Model and serial numbers are on the nameplate on the bottom of the cabinet.

Model No. _____

Serial No. _____

Date of purchase _____

Dealer's address _____

Phone number _____

SAFETY PRECAUTIONS

The following symbols used in this manual, alert you to potentially dangerous conditions to users, service personnel or the appliance:



WARNING

This symbol refers to a hazard or unsafe practice which can result in severe personal injury or death.



CAUTION

This symbol refers to a hazard or unsafe practice which can result in personal injury or product or property damage.

INSTALLATION LOCATION

- We recommend that this air conditioner be installed properly by qualified installation technicians in accordance with the Installation Instructions provided with the unit.
- Before installation, check that the voltage of the electric supply in your home or office is the same as the voltage shown on the nameplate.



WARNING

- Do not install this air conditioner where there are fumes or flammable gases, or in an extremely humid space such as a greenhouse.
- Do not install the air conditioner where excessively high heat-generating objects are placed.

EG

Avoid: To protect the air conditioner from heavy corrosion, avoid installing the outdoor unit where salty sea water can splash directly onto it or in sulphurous air near a spa.

ELECTRICAL REQUIREMENTS

1. All wiring must conform to the local electrical codes. Consult your dealer or a qualified electrician for details.
2. Each unit must be properly grounded with a ground (or earth) wire or through the supply wiring.
3. Wiring must be done by a qualified electrician.

NOTE

Pull off the power plug from a receptacle, or switch off the breaker, or switch off the power disconnecting mean to isolate the air conditioner from the main power supply when not in use for a long time.

SAFETY INSTRUCTIONS



- Read this Instruction Manual carefully before using this air conditioner. If you still have any difficulties or problems, consult your dealer for help.
- This air conditioner is designed to give you comfortable room conditions. Use this only for its intended purpose as described in this Instruction Manual.







WARNING

- Confirm to authorized dealer or specialist on usage of specified refrigerant type. Using of refrigerant other than the specified type may cause product damage, burst and injury etc.
- Never touch the unit with wet hands.
- Never use or store gasoline or other flammable vapor or liquid near the air conditioner — it is very dangerous.
- Do not use this appliance in a potentially explosive atmosphere.
- This air conditioner has no ventilator for intaking fresh air from outdoors. You must open doors or windows frequently when you use gas or oil heating appliances in the same room, which consume a lot of oxygen from the air. Otherwise there is a risk of suffocation in an extreme case.
- Do not swallow the battery.
- After removing the battery from remote controller, keep it away from the reach of children. The battery can cause death by suffocation if swallowed.
- When inserting the battery, make sure the polarities (+ and -) are correct.

**WARNING**

- To prevent possible hazards from insulation failure, the unit must be grounded. 
- Do not clean inside the indoor and outdoor units by users. Engage authorized dealer or specialist for cleaning.
- In case of malfunction of this appliance, do not repair by yourself. Contact to the sales dealer or service dealer for a repair.
- Refrigerant gas leakage may cause fire.
- For safety, be sure to turn the air conditioner off and also to disconnect the power before cleaning. 
- Pull off the power plug from a receptacle, or switch off the breaker, or switch off the power disconnecting mean to isolate the air conditioner from the main power supply in case of emergency.

**CAUTION**

- Do not turn the air conditioner on and off from the power mains switch. Use the ON/OFF operation button.
- Do not stick anything into the air outlet of the outdoor unit. This is dangerous because the fan is rotating at high speed. 
- Do not touch the air inlet or the sharp aluminum fins of the outdoor unit. You may get injured. 
- Keep the fire alarm and the air outlet at least 1.5m away from the unit.
- Do not let children play with the air conditioner.
- Do not cool or heat the room too much if babies or invalids are present.
- Do not sit or step on the unit. You may fall down accidentally. 
- Do not stick any object into the FAN CASE. You may be injured and the unit may be damaged. 

NOTICE

- **This device complies with part 15 of the FCC Rules.**
Operation is subject to the following two conditions:
(1) This device may not cause harmful interference, and (2) this device must accept any interference received, including interference that may cause undesired operation.
- **This equipment has been tested and found to comply with the limits for a Class B digital device, pursuant to part 15 of the FCC Rules.**
These limits are designed to provide reasonable protection against harmful interference in a residential installation. This equipment generates, uses and can radiate radio frequency energy and, if not installed and used in accordance with the instructions, may cause harmful interference to radio communications. However, there is no guarantee that interference will not occur in a particular installation. If this equipment does cause harmful interference to radio or television reception, which can be determined by turning the equipment off and on, the user is encouraged to try to correct the interference by one or more of the following measures:
 - Reorient or relocate the receiving antenna.
 - Increase the separation between the equipment and receiver.
 - Connect the equipment into an outlet on a circuit different from that to which the receiver is connected.
 - Consult the dealer or an experienced radio/TV technician for help.
- FCC Caution: To assure continued compliance, follow the attached installation instructions. Any changes or modifications not expressly approved by the party responsible for compliance could void the user's authority to operate this equipment.

NAMES OF PARTS

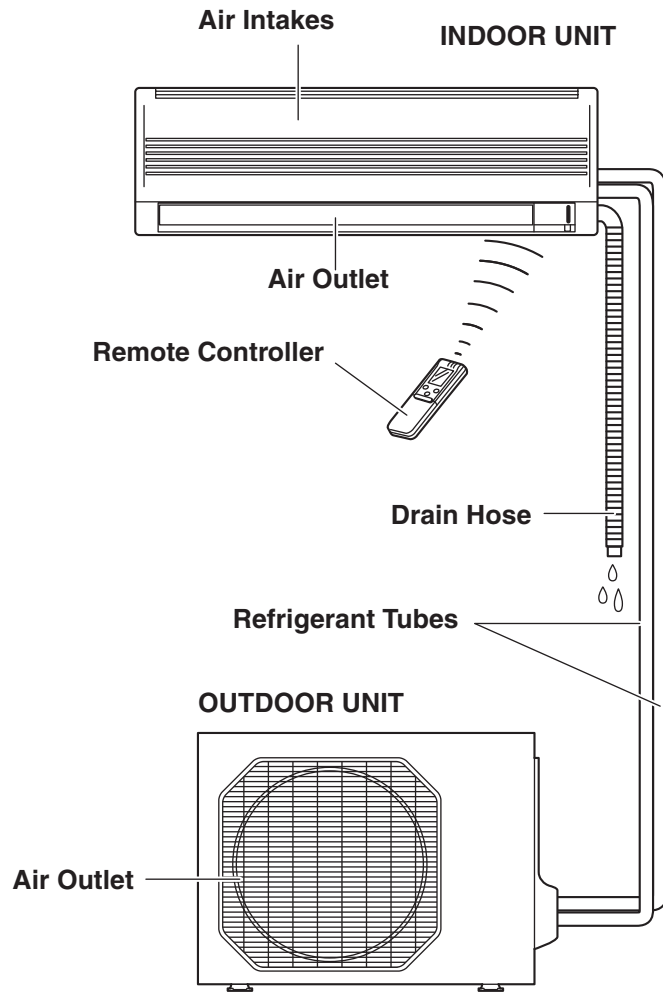

EG

NOTE

This illustration is based on the external view of a standard model. Consequently, the shape may differ from that of the air conditioner which you have selected.

This air conditioner consists of an indoor unit and an outdoor unit. You can control the air conditioner with the remote controller.

Air Intake	Air from the room is drawn into this section and passes through air filters which remove dust.
Air Outlet	Conditioned air is blown out of the air conditioner through the air outlet.
Remote Controller	The remote controller controls power ON/OFF, operation mode selection, temperature, fan speed, timer setting, and air sweeping.
Refrigerant Tubes	The indoor and outdoor units are connected by copper tubes through which refrigerant gas flows.
Drain Hose	Moisture in the room condenses and drains off through this hose.
Outdoor (Condensing) Unit	The outdoor unit contains the compressor, fan motor, heat exchanger coil, and other electrical components.

UNIT DISPLAY AND OPERATION BUTTON



IMPORTANT

Avoid using radio equipment such as mobile phone near (within 4 ft. (1.2m)) the remote control receiver. Some radio equipment may cause malfunction of the unit.

If the trouble happens, disconnect power and restart the air conditioner after a few minutes.

INDOOR UNIT

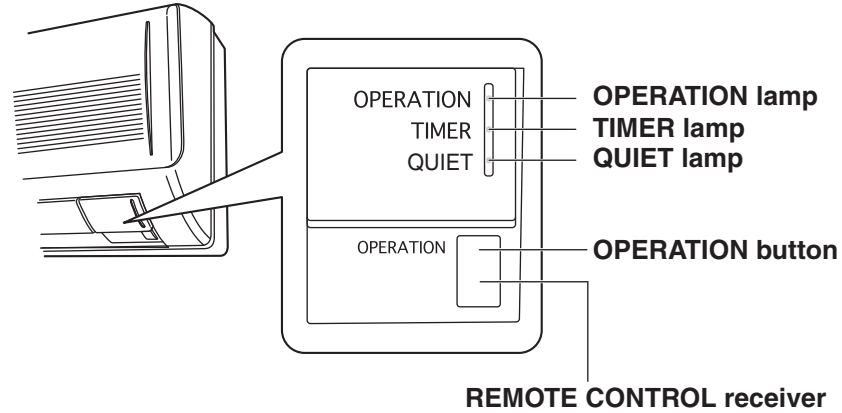

REMOTE CONTROL receiver	This section picks up infrared signals from the remote controller (transmitter).
OPERATION button	<p>When the remote controller cannot be used, pressing this button enables cooling operation.</p> <p>Each time this button is pressed, the operation mode changes cyclically.</p> <div style="text-align: center;"> <p>Cooling operation \longrightarrow Stop</p> </div>
OPERATION lamp	This lamp lights when the system is in the continuous DRY (orange), COOL (green) and FAN (green) mode.
TIMER lamp	This lamp lights when the system is being controlled by the timer.
QUIET lamp	This lamp lights during operation in the QUIET mode.

NOTE

The unit's display lamps are dimmed during operation in the NIGHT SETBACK mode.

REMOTE CONTROLLER (DISPLAY)

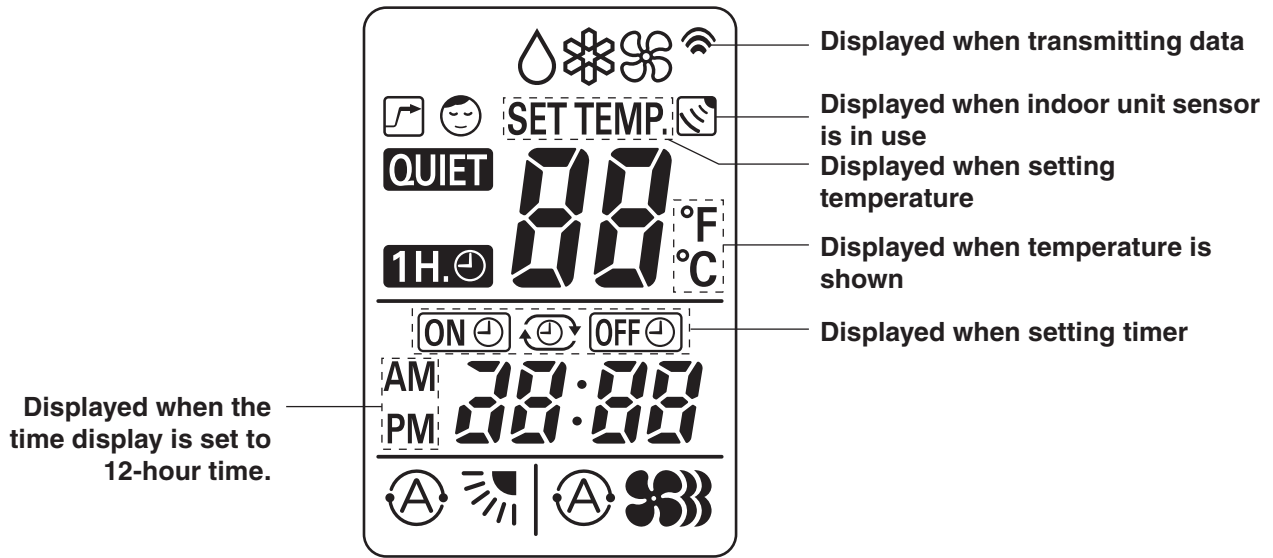

EG

Symbols

(1) Operation mode

MILD DRY



COOL



FAN



(2) Fan speed

Automatic operation



HIGH



MEDIUM



LOW



(3) Temperature setting

60 – 86 °F
When set to 80 °F
temperature indication

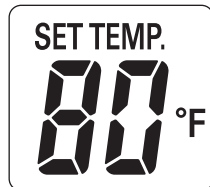

(4) Timer

24-hour clock with ON/OFF
program Timer

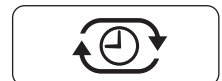

ON Timer



OFF Timer



1-hour OFF Timer



(5) NIGHT SETBACK



(6) Confirmation of transmission



(7) Auto. flap indication



Flap angle indication



Sweep indication



(8) High power operation



(9) Quiet operation



REMOTE CONTROLLER

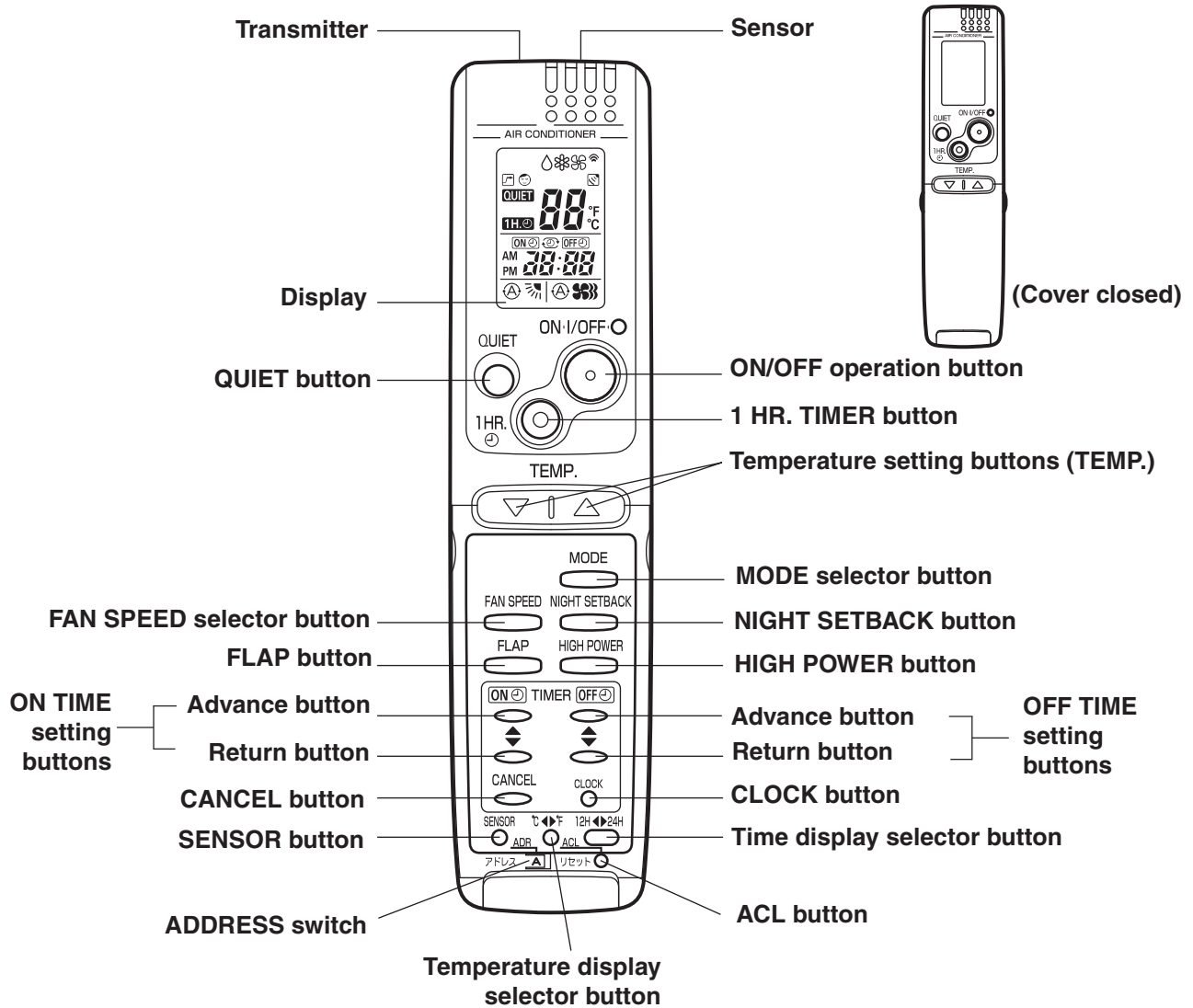

















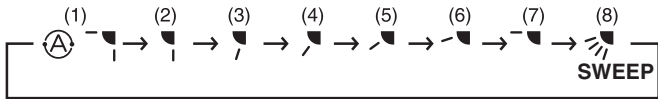

NOTE

The illustration above pictures the remote controller after the cover has been opened.

Transmitter	When you press the buttons on the remote controller, the  mark appears in the display to transmit the setting changes to the receiver in the air conditioner.
Sensor	A temperature sensor inside the remote controller senses the room temperature.
Display	Information on the operating conditions is displayed while the remote controller is switched on. If the unit is turned off, FLAP setting and FAN SPEED setting are not displayed.
QUIET button	QUIET : When you press this button, the fan rotates slower than the fan speed setting to provide a quieter operating sound.
ON/OFF operation button	This button is for turning the air conditioner on and off.
1 HR. TIMER button (1-HOUR OFF TIMER)	1H. : When you press this button, regardless of whether the unit is operating or stopping, the unit operates for one hour and then shuts down.

REMOTE CONTROLLER (CONTINUED)

<p>Temperature setting buttons (TEMP.)</p>	<p>Press the  button to increase the set temperature. Press the  button to reduce the set temperature. The temperature setting changes by 1 °C or 2 °F each time one of the TEMP. buttons is pressed.</p>
<p>MODE selector button (DRY) (COOL) (FAN)</p>	<p>Use this button to select DRY, COOL or FAN mode.</p> <ul style="list-style-type: none">  : The air conditioner reduces the humidity in the room.  : The air conditioner makes the room cooler.  : The air conditioner works only as a circulation fan.
<p>FAN SPEED selector button</p>	<ul style="list-style-type: none">  : The air conditioner automatically decides the fan speeds.  : High fan speed  : Medium fan speed  : Low fan speed
<p>NIGHT SETBACK button</p>	<p>For details, see “4. Night Setback Mode”. When you press this button in the DRY or COOL mode, the  mark appears in the display, and the remote controller will automatically adjust the set temperature to save energy.</p>
<p>FLAP button</p> <p style="text-align: right; border: 1px solid black; padding: 2px; width: fit-content;">NOTE</p>	<p>Press this button either to select the setting of the airflow direction to the auto. flap in each mode or one of the six possible positions manually or to select the sweep function which moves the flap up and down automatically.</p> <ul style="list-style-type: none">  : Auto flap setting: If selected in a cooling or dry operation, the flap is set at position (7) in the following chart.  : The airflow direction can be set manually. (six positions)  : The flap moves up and down automatically. <p>When you press the FLAP button, the air flow direction will be changed one by one as follows.</p> <div style="text-align: center;">  </div>
<p>HIGH POWER button</p>	<ul style="list-style-type: none">  : If this button is pressed during DRY, COOL or FAN operation, the unit operates at maximum output for 30 minutes, regardless of the desired temperature. The fan speed is 1 step above “High”.
<p>ON TIME/OFF TIME setting buttons</p>	<p>No display: The timer does not operate.</p> <ul style="list-style-type: none">  : The air conditioner starts at the set time.  : The air conditioner stops at the set time.  : The air conditioner stops and starts, or starts and stops, at the set times every day. For details, see “SETTING THE TIMER”.
<p>SENSOR button</p> <p style="text-align: right; border: 1px solid black; padding: 2px; width: fit-content;">NOTE</p>	<p>When you press this button (use a small-tipped object such as a ballpoint pen), the  mark will appear at the display. And the room temperature is detected by the sensor which is built into the indoor unit and the air conditioner is controlled accordingly.</p> <p>If the remote controller is located near a heat source, such as a space heater or in direct sunlight, press the SENSOR button to switch to the sensor on the indoor unit.</p>

EG

NOTE The indoor fan runs continuously when the system is in normal operation. It does not turn off when the desired room temperature is reached. If Night Set Back mode is selected, the fan will turn off intermittently during cooling operation in order to control air flow.

REMOTE CONTROLLER (CONTINUED)

Temperature Display Selector button	This switches the temperature display between °C and °F.
Time Display Selector button	This switches the time display between 24-hour time and 12-hour time.
ACL button (ALL CLEAR)	Puts the remote controller into pre-operation status. Always press this button after replacing the batteries.
ADDRESS switch	<ul style="list-style-type: none"> The address switch changes to prevent mixing of signals from remote controller's when two air conditioners are installed next to each other. Normally, the address switch is set to A. For more information, please contact the dealer where you made the purchase. Normally, the tabs on the remote controller should not be bent.

NOTE The remote controller sends the temperature signal to the air conditioner regularly at five minute intervals. If the signal from the remote controller stops for more than 15 minutes due to the loss of the remote controller or other trouble, the air conditioner will switch to the temperature sensor which is built into the indoor unit and control the room temperature. In these cases, the temperature around the remote controller may differ from the temperature detected at the air conditioner's position.

USING THE REMOTE CONTROLLER

How to Install Batteries

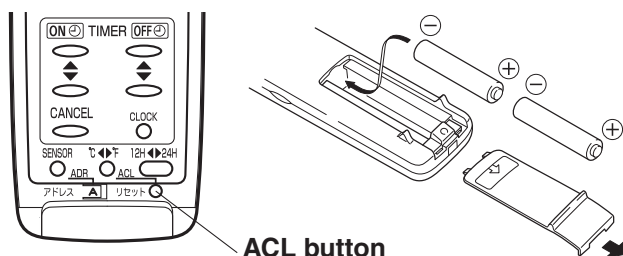

- Slide the cover in the direction indicated by the arrow and remove it.
- Install two AAA alkaline batteries. Make sure the batteries point in the direction marked in the battery compartment.
- Use a thin object such as the tip of a pen to press the ACL button.



CAUTION

- The batteries last about six months, depending on how much you use the remote controller. Replace the batteries when the remote controller's display fails to light, or when the remote controller cannot be used to change the air conditioner's settings.
- Use two fresh leak-proof type-AAA alkaline batteries.
- In replacing batteries, follow the instructions as mentioned in the subsection "How to Install Batteries".
- If you do not use the remote controller more than 1 month, take out the batteries.
- Dispose of the used batteries at the designated location in compliance with the applicable local ordinances.

Information for Users on Collection and Disposal of Old Equipment and used Batteries



[Information on Disposal in other Countries outside the European Union]
These symbols are only valid in the European Union. If you wish to discard these items, please contact your local authorities or dealer and ask for the correct method of disposal.



Pb

Note for the battery symbol (bottom two symbol examples):

This symbol might be used in combination with a chemical symbol. In this case it complies with the requirement set by the Directive for the chemical involved.

USING THE REMOTE CONTROLLER (CONTINUED)

How to Use the Remote Controller

When using the remote controller, always point the unit's transmitter head directly at the air conditioner's receiver.

**Air Conditioner
(Indoor unit)**

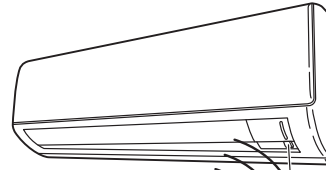

Remote Controller

**Receiver
(Transmitter head)**

EG

Remote Controller Installation Position

The remote controller may be operated either from a non-fixed position or from a wall-mounted position. To ensure that the air conditioner operates correctly, do not install the remote controller in the following places:

- In direct sunlight
- Behind a curtain or other places where it is covered
- More than 26 ft (8 m) away from the air conditioner
- In the path of the air conditioner's airstream
- Where it may become extremely hot or cold
- Where it may be subject to electrical or magnetic noise
- Where there is an obstacle between the remote controller and air conditioner (since a check signal is sent from the remote controller every 5 minutes)

Mounting the Remote Controller

Before mounting the remote controller, press the ON/OFF operation button at the mounting location to make sure that the air conditioner operates from that location. The indoor unit should make a beeping sound to indicate that it has received the signal.

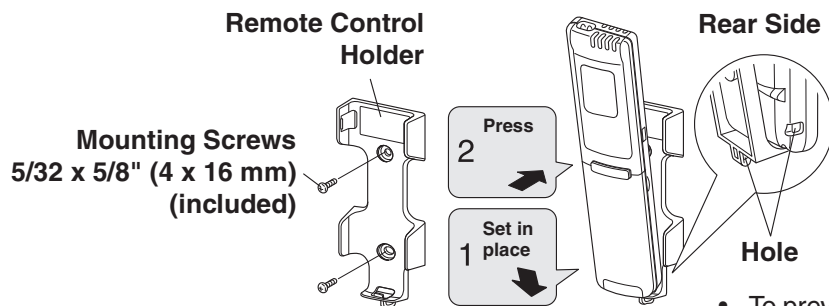

- To prevent loss of the remote controller, you can connect the remote controller to the holder by passing a string through the remote controller and attachment hole.

To take out the remote controller, pull it forward.

When Holding the Remote Controller

- When using the remote controller and during air conditioner operation, the transmitter on the remote controller should be pointed towards the receiver on the indoor unit.
- Make sure that there are no objects between the remote controller and receiver which could block the signal.

OPERATION WITH THE REMOTE CONTROLLER

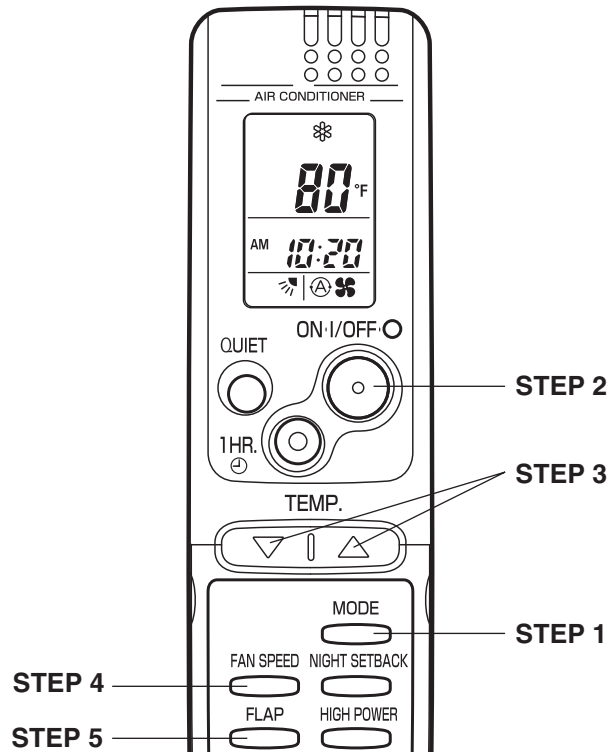

1. Operation



NOTE

Check that the circuit breaker on the power panel is turned on.

Press the setting buttons as described below and change the settings as desired.

STEP 1	Press the MODE selector button and select the desired mode. For dehumidifying operation →  For cooling operation →  For fan only operation → 
STEP 2	To start the air conditioner, press the ON/OFF operation button.
STEP 3	Press the TEMP. setting buttons to change the temperature setting to the desired temperature. Adjustable temperature range: 30 °C max. or 86 °F max. 16 °C min. 60 °F min.
STEP 4	Set the FAN SPEED selector button to the setting you want.
STEP 5	Press the FLAP button and set the airflow direction as desired. (Refer to “ADJUSTING THE AIRFLOW DIRECTION” on page 20.)

To stop the air conditioner, press the ON/OFF operation button again.

OPERATION WITH THE REMOTE CONTROLLER (CONTINUED)

NOTE

- Choose the best position in the room for the remote controller, which also acts as the sensor for room comfort and transmits the operating instructions. Once you've found this best position, always keep the remote controller there.
- This appliance has a built-in 5-minute time delay circuit to ensure reliable operation. When the operation button is pressed, the compressor will start running within three minutes. In the event of power failure, the unit will stop.



EG

2. Adjusting the Fan Speed

A. Automatic fan speed

Simply set the FAN SPEED selector button to the  position. This automatically sets the best fan speed for the room temperature.



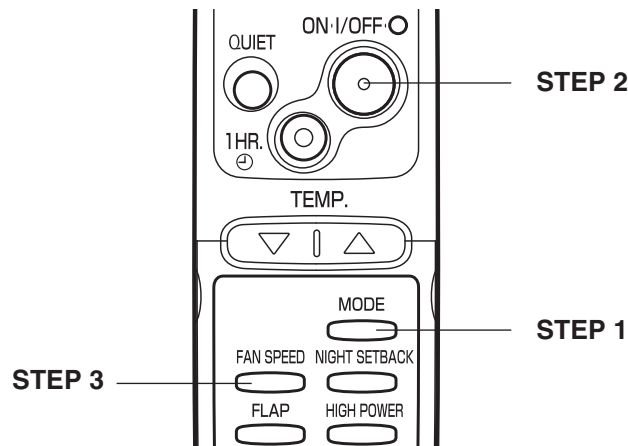

B. Manual fan speed

If you want to adjust fan speed manually during operation, just set the FAN SPEED selector button as desired. [, , or ]

3. Fan Only



If you want to circulate air without any temperature control, follow these steps:

STEP 1	Press the MODE selector button to switch to the fan mode  .
STEP 2	Press the ON/OFF operation button.
STEP 3	Press the FAN SPEED selector button to select the fan speed of your choice ( ,  , or ).

OPERATION WITH THE REMOTE CONTROLLER (CONTINUED)

4. Night Setback Mode

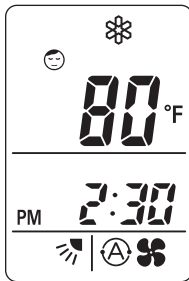

Night Setback Mode is used for saving energy.

Press the NIGHT SETBACK button while unit is operating.
The ☺ mark appears in the display.

To release the night setback function, press the NIGHT SETBACK button again.

NOTE

Pressing the MODE selector button cancels Night Setback mode.

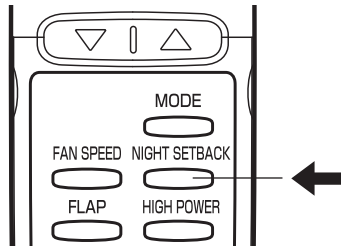

In Cooling and DRY Mode: (❄️ and 💧)

When the night setback mode is selected, the air conditioner automatically raises the temperature setting 2 °F when 30 minutes have passed after the selection was made, and then another 2 °F after another 30 minutes have passed, regardless of the indoor temperature when night setback was selected. This enables you to save energy without sacrificing comfort. This function is convenient when gentle cooling is needed.

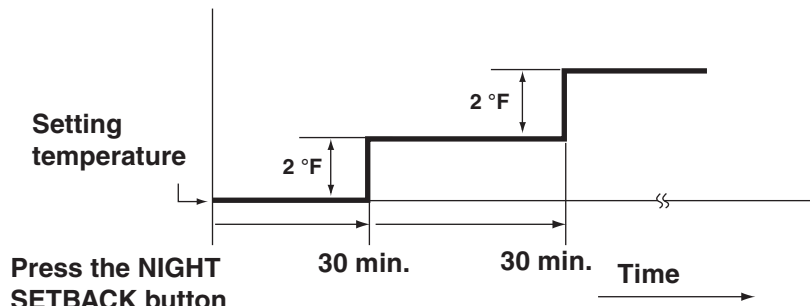

OPERATION WITH THE REMOTE CONTROLLER (CONTINUED)

5. QUIET Mode

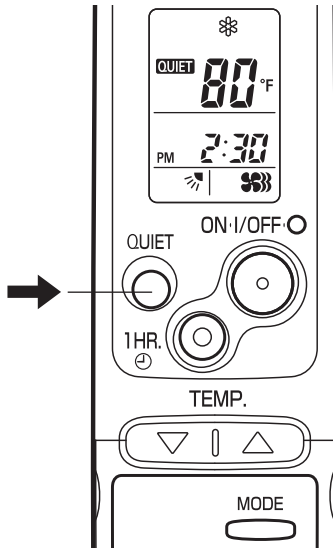

QUIET Mode is used to reduce the fan sound of the indoor unit.

Press the QUIET button.

The **QUIET** mark appears in the display.

To cancel, press QUIET button again.

- In QUIET Mode, the fan rotates at a slower speed than the fan speed setting.
- If the unit is already operating with a very low airflow, the fan sound may not change even if the QUIET button is pressed.

EG

6. HIGH POWER Mode

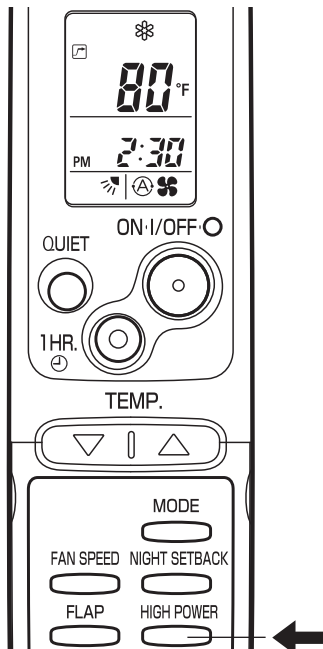

HIGH POWER mode can be used to increase the output of the indoor unit for all operation modes.

Press the HIGH POWER button while unit is operating.

The  mark appears in the display.

To cancel, press HIGH POWER button again.

- When the HIGH POWER button is pressed, the unit operates at maximum output for 30 minutes, regardless of the desired temperature. The fan speed is 1 step above "High".
- QUIET Mode and HIGH POWER Mode cannot be used at the same time.

NOTE

- Pressing the MODE selector button cancels HIGH POWER mode.
- Depending on the operating conditions, the fan speed may be increased by a small amount only.

SPECIAL REMARKS

“DRY” (☾) Operation

How it works?

- Once the room temperature reaches the level that was set, the unit’s operation frequency is changed automatically.
- During DRY operation, the fan speed automatically runs at lower speed for providing a comfortable breeze.
- “DRY” operation is not possible if the indoor temperature is 59 °F or less.

Cooling (☼) Operation

- Sometimes the indoor unit may not get to the set fan speed such as LOW and QUIET under cool operation at very low outdoor temperatures due to the indoor unit being protected from ice or frost when combined with the outdoor unit for Low Ambient Cooling models.

Power failure during operation

- In the event of power failure, the unit will stop. When the power is resumed, the unit will restart automatically within 15 minutes by the remote controller.

Clicking Sound

Clicking sound is heard from the air conditioner

- In cooling operation, any plastic parts may shrink due to a sudden temperature change. In this event, a clicking sound may occur. This is normal, and the sound will soon disappear.

Remote Controller

- The remote controller sends the setting condition to the air conditioner regularly at five minute intervals.

SETTING THE TIMER

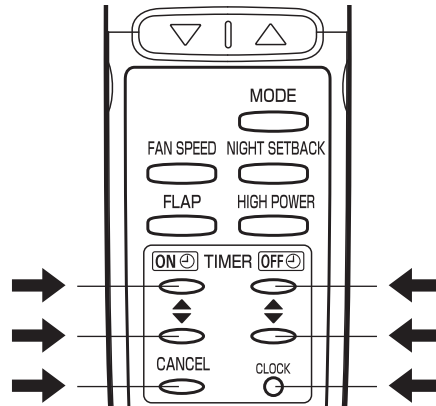

EG

NOTE

In the descriptions below, the following settings are used for the temperature and time indicator selector button on the bottom front section of the remote controller.

- Temperature: °F
- Time: AM, PM

1. How to set the present time

(Example) To set to 10:30 pm.

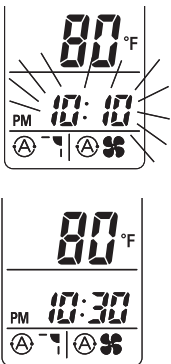

Operation	Indication
1. Press the CLOCK button once if the time indicator is not flashing.	The time indication alone flashes.
2. Press the Advance, Return (▲, ▼) button until PM 10:30 is displayed.	The time can be set in 1-minute increments. Holding down the button advances the time rapidly in 10-minute increments.
3. Press the CLOCK button again.	This completes the setting of the current time.

2. How to set the OFF time

(Example) To stop the air conditioner at 11:00 am.



Operation	Indication
1. Press the OFF TIME setting button once.	The timer OFF indication is displayed, and the present OFF time is shown.
2. Press the Advance, Return (▲, ▼) button until AM 11:00 is displayed.	The timer OFF indication blinks. The time can be set in 10-minute increments. Holding down the button advances the time rapidly in 10-minute increments.
3. Wait a few seconds, and then the setting is complete.	The timer OFF indication stops blinking and the present time is displayed.

SETTING THE TIMER (CONTINUED)

3. How to set the ON time

(Example) To start operation at 7:10 am.

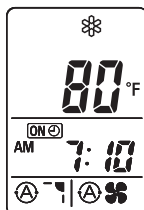

Operation	Indication
1. Press the ON TIME setting button once.	The timer ON indication is displayed, and the present ON time is shown.
2. Press the Advance, Return (▲, ▼) button until AM 7:10 is displayed.	The timer ON indication blinks. The time can be set in 10-minute increments. Holding down the button advances the time rapidly in 10-minute increments.
3. Wait a few seconds, and then the setting is complete.	The timer ON indication stops blinking and the present time is displayed.

4. How to set DAILY ON/OFF REPEAT timer

(Example) To start operation at 7:10 am. and stop the air conditioner at 11:00 am.

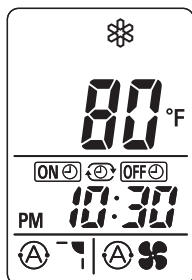
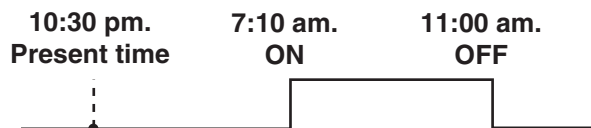

Operation	Indication
1. Set the timer ON/OFF times as shown in 2-1, 2, 3 and 3-1, 2, 3.	The present time 10:30 pm. and ON OFF are displayed.

NOTE

- The ON/OFF combination timer uses the current time as the reference, and it is activated starting from whichever set time comes first.
- With the ON/OFF combination timer, the settings are repeated every day.
- You can check the timer ON/OFF times after you have set them by pressing the ON TIME and OFF TIME setting buttons.

To cancel a timer program

- Press the CANCEL button.
- When either an ON or OFF timer is to be canceled, press the button corresponding to the timer whose program is to be canceled, and then press the CANCEL button.

NOTE

- The airflow direction, fan speed and temperature setting can be changed after a timer program has been set even when the unit is stopped. Even when operation is stopped during an ON timer program, the unit will start operating when the set time is reached provided that the program is not canceled.
- When the ON timer and OFF timer are set to the same time, the timer operates as if it is turned off.

USING THE 1-HOUR OFF TIMER

1. 1-Hour OFF Timer

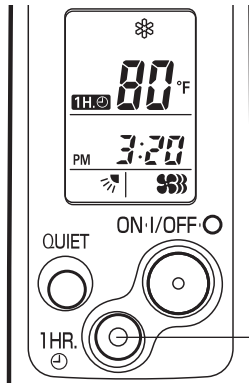

This function causes the unit to operate for one hour and then stop, regardless of whether the unit is on or off when this button is pressed. The **1H.** indicator in the display indicates that this function is operating.

Setting procedure:

Regardless of whether the unit is operating or stopped, press the 1 HR. TIMER button.

1H. appears in the display.

Cancellation procedure:

Press the ON/OFF operation button to turn the unit off, wait for the unit to stop operating, and then press the ON/OFF operation button again.

The 1-Hour Timer function is now cancelled and the unit operates normally.

NOTE

- If, while the 1-Hour Timer function is operating, the 1HR. TIMER button is pressed once to cancel the function and then again, the unit continues to operate for one hour from that point in time and then stops.
- It is not possible to use the OFF Timer and 1-Hour OFF Timer together. Whichever function is set last takes precedence. If the 1 HR. TIMER button is pressed while the TIMER OFF function operates, the OFF Timer is cancelled and the unit will stop operating one hour later.

2. Operation together with the DAILY ON/OFF REPEAT Timer

The 1-Hour OFF Timer setting is given priority over the DAILY ON/OFF REPEAT setting.

TIPS FOR ENERGY SAVING

- Avoid**
- **Do not block neither the air intake nor the air outlet. It may cause less performance, and may leads to malfunctions.**
 - Do not let direct sunlight into the room. Use sunshades, blinds or curtains. If the walls and ceiling of the room are warmed by the sun, it will take longer to cool the room.
- Do**
- Always try to keep the air filter clean. (Refer to “CARE AND CLEANING”.) A clogged filter will impair the performance of the unit.
 - To prevent conditioned air from escaping, keep windows, doors and any other openings closed.

ADJUSTING THE AIRFLOW DIRECTION

- 1. Horizontal** The horizontal airflow can be adjusted by moving the vertical vanes with your hands to the left or right.

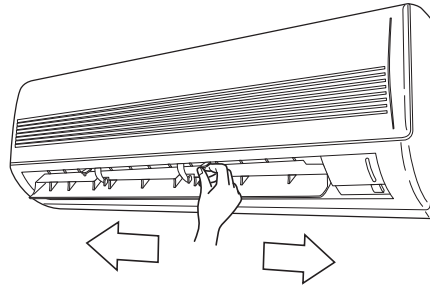

CAUTION

When the humidity is high, the vertical vanes should be in the front position during the cooling or dehumidifying operation. If the vertical vanes are positioned all of the way to the right or left, condensation may begin to form around the air vent and drip down.

- 2. Vertical** The vertical airflow can be adjusted by moving the flap with the remote controller. Do not move the flap with your hands. Confirm that the remote controller has been turned on. Use the FLAP button to set either the sweep function or one of the six airflow direction settings.

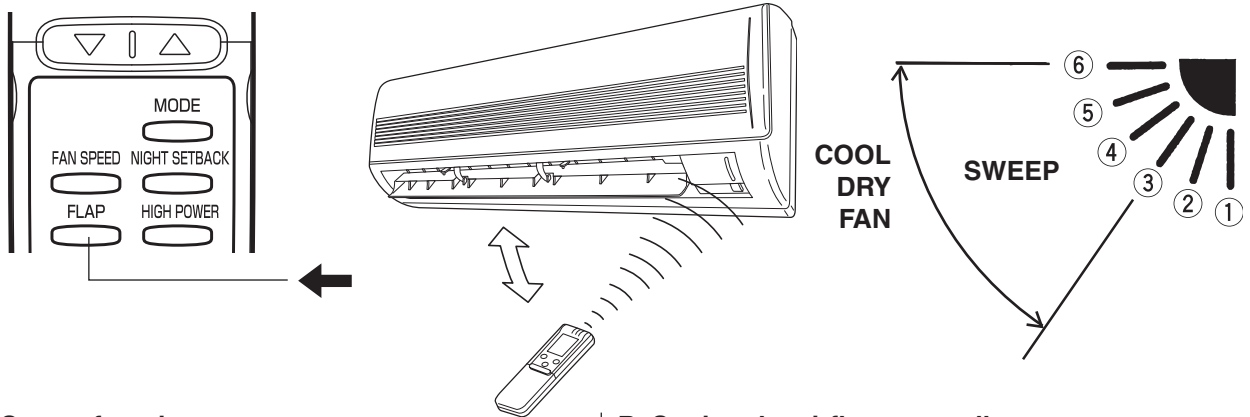

A. Sweep function



The flap starts moving up and down to deliver air over the sweep range.

C. Auto flap function



The flap is set to the recommended position.

B. Setting the airflow manually



Referring to the above illustration, use the FLAP button to set the airflow direction within the range used during the cooling or dehumidifying operation.

NOTE

- The flap automatically closes when the unit is off.



CAUTION

- Use the FLAP button on the remote controller to adjust the position of the flap. If you move the flap by hand, the flap position according to the remote controller and the actual flap position may no longer match. If this should happen, shut off the unit, wait for the flap to close, and then turn on the unit again; the flap position will now be normal again.
- Do not have the flap pointed down during cooling operation. Condensation may begin to form around the air vent and drip down.

OPERATION WITHOUT THE REMOTE CONTROLLER

INDOOR UNIT

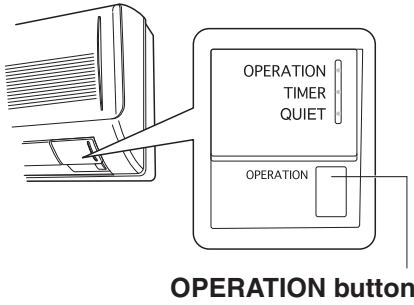

OPERATION button

If you have lost the remote controller or it has trouble, follow the steps below.

When the air conditioner is not running

Each time the OPERATION button is pressed, the operation mode changes cyclically.



NOTE

The temperature is set to the room temperature minus 4 °F during the cooling operation, and the fan speed and flap are set to Auto.

EG

CARE AND CLEANING



WARNING

1. For safety, be sure to turn the air conditioner off and also to disconnect the power before cleaning.
2. Do not pour water on the indoor unit to clean it. This will damage the internal components and cause an electric shock hazard.

Casing and Grille (Indoor Unit)

Clean the casing and grille of the indoor unit with a vacuum cleaner brush, or wipe them with a clean, soft cloth.

If these parts are stained, use a clean cloth moistened with a mild liquid detergent. When cleaning the grille, be careful not to force the vanes out of place.



CAUTION

1. Never use solvents, or harsh chemicals when cleaning the indoor unit. Do not wipe the plastic casing using very hot water.
2. Some metal edges and the fins are sharp and may cause injury if handled improperly; be especially careful when you clean these parts.
3. The internal coil and other components of the outdoor unit must be cleaned every year. Consult your dealer or service center.

CARE AND CLEANING (CONTINUED)

Filter The filter behind the air intake grille should be checked and cleaned at least once every two weeks.

How to remove the filter

1. Grasp both ends of the air intake grille, and remove it by opening towards the front and pulling towards you.

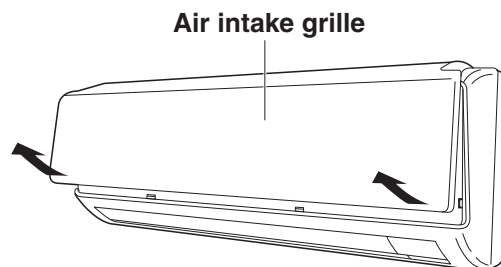

2. Remove the filter attached to the rear of the air intake grille.

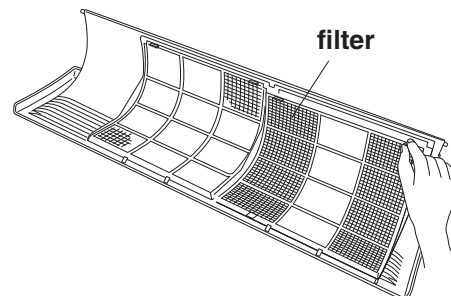

Cleaning Use a vacuum cleaner to remove light dust. If there is sticky dust on the filter, wash the filter in lukewarm, soapy water, rinse it in clean water, and dry it.

How to replace the filter

1. With the FRONT mark of the filter at the front, align the two indentions near the mark with the hooks at the rear of the air intake grille, and then mount the filter.

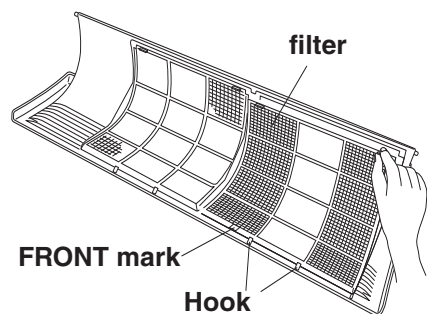

2. Allow the edge of the air intake grille to slide into the top of the indoor unit, and then insert it all the way inside.

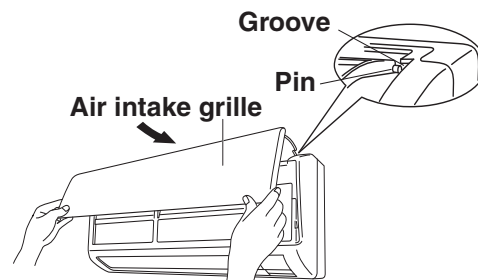

3. To attach the air intake grille to the indoor unit, press its bottom right and left corners as well as its bottom center into place.

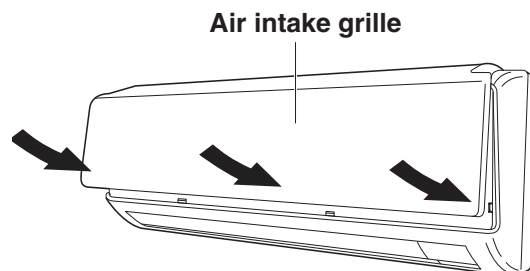

NOTE

Attach so that the round pins at the top right and left corners of the air intake grille are inserted into the grooves at the top right and left of the indoor unit.

CARE AND CLEANING (CONTINUED)

Cleaning the main unit and Remote Controller

- Wipe clean using a soft, dry cloth.
- To remove stubborn dirt, moisten a cloth in warm water no hotter than 104 °F, wring thoroughly, and then wipe.
- The air intake grille can be removed in order to wash it with water.

Removing and remounting the air intake grille

Refer to “How to remove the filter” and “How to replace the filter” on page 22.



CAUTION

When using a footstool or the like, be careful not to let it tip over.

EG

Washing the grille with water

- Clean the grille gently using a soft sponge, or the like. Then wipe away any remaining moisture.
- Neutral detergent may be used to remove stubborn dirt. Then rinse thoroughly with water and wipe away any remaining moisture.

WIRED REMOTE CONTROLLER

A separately sold wired remote controller (CZ-RD515U) used with this air conditioner is also available. If you wish to use the wired remote control function, you will need to purchase both the optional wired remote controller and its connection kit (CZ-RC515U).

TROUBLESHOOTING (BEFORE CALLING FOR SERVICE)

If your air conditioner does not work properly, first check the following points before requesting service. If it still does not work properly, contact your dealer or service center.

Trouble	Possible Cause	Remedy
Air conditioner does not run at all.	<ol style="list-style-type: none"> 1. Power failure. 2. Leakage circuit breaker tripped. 3. Line voltage is too low. 4. Batteries in remote controller have run down. 	<ol style="list-style-type: none"> 1. Restore power. 2. Contact service center. 3. Consult your electrician or dealer. 4. Replace batteries.
OPERATION lamp blinks and air conditioner does not operate.	Trouble in system.	Contact service center.
Compressor runs but soon stops.	Obstruction in front of condenser coil. (Outdoor Unit)	Remove obstruction.
Poor cooling performance.	<ol style="list-style-type: none"> 1. Dirty or clogged air filter. 2. Heat source or many people in room. 3. Doors and/or windows are open. 4. Obstacle near air intake or air discharge port. 5. Thermostat is set too high for cooling. 	<ol style="list-style-type: none"> 1. Clean air filter to improve airflow. 2. Eliminate heat source if possible. 3. Shut them to keep the heat out. 4. Remove it to ensure good airflow. 5. Set the temperature lower.
Clicking sound is heard from the air conditioner.	In cooling operation, any plastic parts may shrink due to a sudden temperature change. In this event, a clicking sound may occur.	This is normal, and the sound will soon disappear.
OPERATION lamp lights but outdoor unit will not run.	The use of cellular phones near the air conditioner may cause disturbance to its normal operation.	<ol style="list-style-type: none"> 1. Turn off the power then restart the air conditioner after a while. 2. Consult your dealer.

OPERATING RANGE

The air conditioner is operable within the temperature ranges as listed below:

	Temperature	Indoor air temperature	Outdoor air temperature
COOLING	Max.	95 °F DB / 71 °F WB	115 °F DB
	Min.	67 °F DB / 57 °F WB	14 °F DB

SPECIFICATIONS

Model No.		Indoor Unit	
		CS-MKS18NKU	CS-MKS24NKU
Power Source		Single-phase, 208-230 V, 60 Hz	
Cooling Capacity	kW	5.15	7.10
	BTU/h	17,500	24,200
Heating Capacity	kW	–	–
	BTU/h	–	–
Operation Sound	Cooling Operation (H/M/L) dB(A)	41/38/34	44/41/38
	Heating Operation (H/M/L) dB(A)	–	–
Unit Dimensions (H×W×D) (Indoor unit : Include panel)		inch(mm) 11-23/32×41-15/16×8-5/8 (298×1,065×219)	11-23/32×41-15/16×8-5/8 (298×1,065×219)
Net Weight		lbs.(kg) 26.5(12.0)	26.5(12.0)

EG

Model No.		Outdoor Unit		
		CU-3KS19NBU	CU-4KS24NBU	CU-4KS31NBU
Power Source		Single-phase, 208-230 V, 60 Hz		
Cooling Capacity	kW	5.50 [2.90 ~ 5.50]	7.50 [2.90 ~ 7.50]	9.00 [2.90 ~ 9.00]
	BTU/h	18,800 [9,800 ~ 18,800]	25,400 [9,800 ~ 25,400]	30,600 [9,800 ~ 30,600]
Heating Capacity	kW	–	–	–
	BTU/h	–	–	–
Operation Sound	Cooling Operation (Hi) dB(A)	50	50	53
	Heating Operation (Hi) dB(A)	–	–	–
Unit Dimensions (H×W×D)		inch(mm) 29-1/8×35-7/16×12-19/32 (740×900×320)	29-1/8×35-7/16×12-19/32 (740×900×320)	35-1/32×35-7/16×12-19/32 (890×900×320)
Net Weight		lbs.(kg) 138.9(63.0)	138.9(63.0)	174.2(79.0)